

OPERATOR'S MANUAL

AVCO LYCOMING O-360 and Associated Models. AIRCRAFT ENGINES

Approved by F.A.A.

Jan. 1976

3rd Edition

Part No. 60297-12

Price \$5.00

 **AVCO** LYCOMING DIVISION
WILLIAMSPORT, PENNSYLVANIA

Printed in U. S. A.

ATTENTION

OWNERS, OPERATORS, AND MAINTENANCE PERSONNEL

This operator's manual contains a description of the engine, its specifications, and detailed information on how to operate and maintain it. Such maintenance procedures that may be required in conjunction with periodic inspections are also included. This manual is intended for use by owners, pilots and maintenance personnel responsible for care of Avco Lycoming powered aircraft. Modifications and repair procedures are contained in Avco Lycoming overhaul manuals; maintenance personnel should refer to these for such procedures.

SAFETY WARNING

Neglecting to follow the operating instructions and to carry out periodic maintenance procedures can result in poor engine performance and power loss. Also, if power and speed limitations specified in this manual are exceeded, for any reason; damage to the engine and personal injury can happen. Consult your local FAA approved maintenance facility.

SERVICE BULLETINS, INSTRUCTIONS, AND LETTERS

Although the information contained in this manual is up-to-date at time of publication, users are urged to keep abreast of later information through Avco Lycoming Service Bulletins, Instructions and Service Letters which are available from all Avco Lycoming distributors or from the factory by subscription. Consult the latest edition of Service Letter No. L114 for subscription information.

SPECIAL NOTE

The illustrations, pictures and drawings shown in this publication are typical of the subject matter they portray; in no instance are they to be interpreted as examples of any specific engine, equipment or part thereof.



LIMITED STANDARD WARRANTY

Avco Lycoming Williamsport Division, AVCO Corporation (Avco Lycoming), warrants each new or remanufactured aircraft engine and each new replacement part therefor sold by it to be free from defects in material or workmanship, under normal use and service, for six calendar months from the date of first operation by the first user.

The obligation of Avco Lycoming under this warranty shall be limited to the repair or replacement at Avco Lycoming's election, of the engine or any part thereof, or of the replacement part, when a claim is made in accordance with the Avco Lycoming Warranty Application Procedure and Avco Lycoming has determined that the engine or part is not as warranted. Such repair or replacement will be made by Avco Lycoming at no charge to the holder of this warranty and Avco Lycoming will assume costs for labor in connection therewith as provided in Avco Lycoming's Removal and Installation Labor Allowance Guide Book. Any engine or part installed in the course of such repair or replacement will be warranted for the remainder of the original warranty period.

No claim shall be allowed under this warranty if in the opinion of Avco Lycoming the engine or part has been subjected to accident or used, adjusted, altered, handled, maintained or stored other than as directed in Avco Lycoming's Operator's Manual.

No agreement varying this warranty or Avco Lycoming's obligations hereunder will be binding upon Avco Lycoming unless executed by its duly authorized employee.

Avco Lycoming reserves the right to change the construction of Avco Lycoming engines at any time without incurring any obligation to incorporate such alterations in engines or parts previously sold.

ANY IMPLIED WARRANTIES APPLICABLE BY LAW TO THIS PRODUCT ARE LIMITED IN DURATION TO THE DURATION OF THE WARRANTY SET FORTH ABOVE. TO THE EXTENT PERMITTED BY LAW, ALL CONSEQUENTIAL DAMAGES ARE EXCLUDED FROM THE COMPUTATION OF DAMAGES FOR THE BREACH OF ANY EXPRESS OR IMPLIED WARRANTY.

Effective September 1, 1975 - Revision "A"

*Avco Lycoming Williamsport Division
Williamsport, Pennsylvania*



LIMITED SPECIAL WARRANTY
FOR

**Premium Packaged Engines and Service Parts*

Avco Lycoming Williamsport Division, AVCO Corporation (Avco Lycoming) warrants each new or remanufactured premium packaged aircraft engine and each new premium packaged replacement part therefor sold by it to be free from defects in material and workmanship under normal use and service for six calendar months from the date of first operation by the first user or six months from the date of removal of the engine or part from the original premium packaging, whichever event shall occur, provided that (1) such packaging has remained sealed and undamaged at all times, (2) the engine and/or part has been stored at all times in a weather-protected, dry area under normal humidity conditions, (3) the humidity indicators installed within the vapor barrier have not shown an unsafe condition at any time, and (4) the storage of such engine and/or part in such premium packaging has not extended beyond six months from the date of shipment from Avco Lycoming's plant in Williamsport, Pennsylvania.

The obligation of Avco Lycoming under this warranty shall be limited to the repair or replacement at Avco Lycoming's election, of the engine or any part thereof, or of the replacement part, when a claim is made in accordance with the Avco Lycoming Warranty Application Procedure and Avco Lycoming has determined that the engine or part is not as warranted. Such repair or replacement will be made by Avco Lycoming at no charge to the holder of the warranty and Avco Lycoming will assume costs for labor in connection therewith as provided in Avco Lycoming's Removal and Installation Labor Allowance Guide Book. Any engine or part installed in the course of such repair or replacement will be warranted for the remainder of the original warranty period.

No claim shall be allowed under this warranty if in the opinion of Avco Lycoming the engine or part has been subjected to accident or used, adjusted, altered, handled, maintained or stored other than as directed in Avco Lycoming's Operator's Manual.

No agreement varying this warranty or Avco Lycoming's obligations hereunder will be binding upon Avco Lycoming unless executed by its duly authorized employee.

Avco Lycoming reserves the right to change the construction of Avco Lycoming engines at any time without incurring any obligation to incorporate such alterations in engines or parts previously sold.

ANY IMPLIED WARRANTIES APPLICABLE BY LAW TO THIS PRODUCT ARE LIMITED IN DURATION TO THE DURATION OF THE WARRANTY SET FORTH ABOVE. TO THE EXTENT PERMITTED BY LAW, ALL CONSEQUENTIAL DAMAGES ARE EXCLUDED FROM THE COMPUTATION OF DAMAGES FOR THE BREACH OF ANY EXPRESS OR IMPLIED WARRANTY.

* The term "premium packaged" shall mean packaging in accordance with Avco Lycoming's Standard Packaging Specifications for export shipment.

Effective: September 1, 1975
Rev. "A"

Avco Lycoming Williamsport Division
Williamsport, Pennsylvania

TABLE OF CONTENTS

		Page
SECTION 1	DESCRIPTION	1-1
SECTION 2	SPECIFICATIONS	2-1
SECTION 3	OPERATING INSTRUCTIONS	3-1
SECTION 4	PERIODIC INSPECTIONS	4-1
SECTION 5	MAINTENANCE PROCEDURES	5-1
SECTION 6	TRUBLE—SHOOTING	6-1
SECTION 7	INSTALLATION AND STORAGE	7-1
SECTION 8	TABLES	8-1

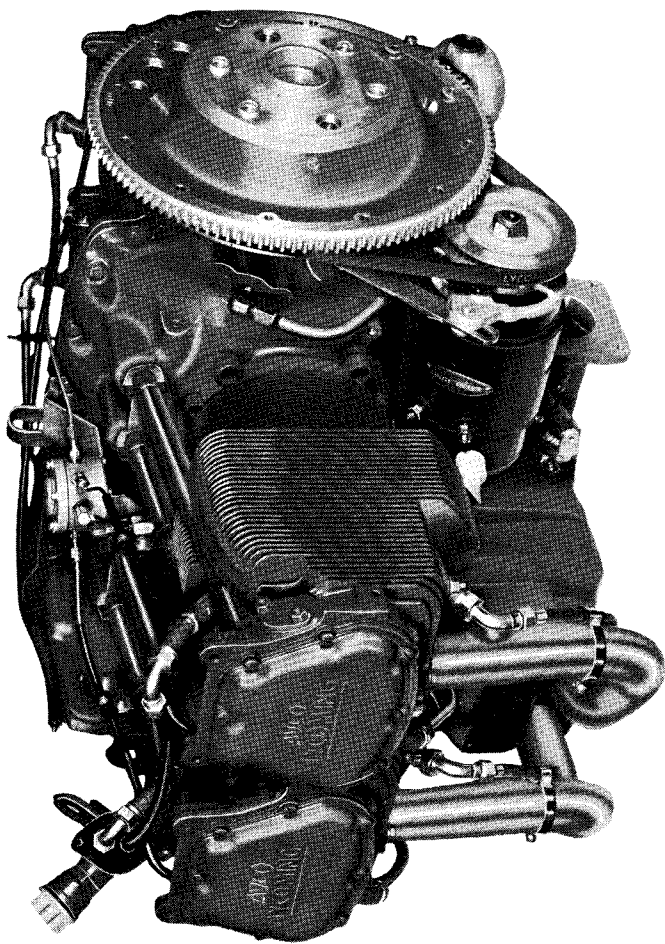

Figure 1. 3/4 Right Side View - IO-360-A1A

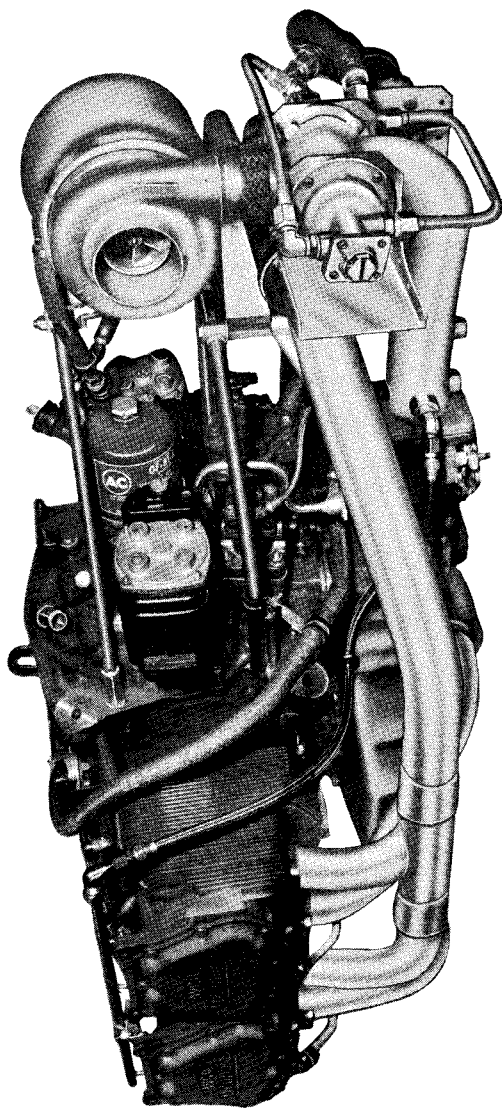

Figure 2. 3/4 Left Rear View - TIO-360-A1B

DESCRIPTION

Page

General1-1
Cylinders1-1
Valve Operating Mechanism1-1
Crankcase1-1
Crankshaft1-2
Connecting Rods1-2
Pistons1-2
Accessory Housing1-2
Oil Sump1-2
Cooling System1-2
Induction System1-2
Lubrication System1-4
Priming System1-4
Ignition System1-4
Model Application Table1-5

SECTION 1**DESCRIPTION**

The O, HO, IO, AIO, HIO, LIO and TIO-360 series are four cylinder, direct drive, horizontally opposed, air cooled engines.

In referring to the location of the various engine components, the parts are described as installed in the airframe. Thus, the power take-off end is the front and the accessory drive end the rear. The sump section is the bottom and the opposite side of the engine where the shroud tubes are located the top. Reference to the left and right side is made with the observer facing the rear of the engine. The cylinders are numbered from front to rear, odd numbers on the right. The direction of rotation of the crankshaft, viewed from the rear, is clockwise. Rotation for accessory drives is determined with the observer facing the drive pad.

NOTE

The letter "L" in the model prefix denotes the reverse rotation of the basic model. Example: model IO-360-C has clockwise rotation of the crankshaft. Therefore, LIO-360-C has counter-clockwise rotation of the crankshaft. Likewise, the rotation of the accessory drives of the LIO-360-C are opposite those of the basic model as listed in Section 2 of this manual.

The letter "D" used as the 4th or 5th character in the model suffix denotes that the particular model employs dual magnetos housed in a single housing. Example: All information pertinent to the O-360-A1F6 will apply to O-360-A1F6D.

Operational aspects of engines are the same and performance curves and specifications for the basic model will apply.

Cylinders - The cylinders are of conventional air cooled construction with the two major parts, head and barrel, screwed and shrunk together. The heads are made from an aluminum alloy casting with a fully machined combustion chamber. Rocker shaft bearing supports are cast integral with the head along with housings to form the rocker boxes. The cylinder barrels have deep integral cooling fins and the inside of the barrels are ground and honed to a specified finish.

SECTION 1

O-360 and ASSOCIATED MODELS

Valve Operating Mechanism - A conventional type camshaft is located above and parallel to the crankshaft. The camshaft actuates hydraulic tappets which operate the valves through push rods and valve rockers. The valve rockers are supported on full floating steel shafts. The valve springs bear against hardened steel seats and are retained on the valve stems by means of split keys.

Crankcase - The crankcase assembly consists of two reinforced aluminum alloy castings, fastened together by means of studs, bolts and nuts. The mating surfaces of the two castings are joined without the use of a gasket, and the main bearing bores are machined for use of precision type main bearing inserts.

Crankshaft - The crankshaft is made from a chrome nickel molybdenum steel forging. All bearing journal surfaces are nitrided.

Connecting Rods - The connecting rods are made in the form of "H" sections from alloy steel forgings. They have replaceable bearing inserts in the crankshaft ends and bronze bushings in the piston ends. The bearing caps on the crankshaft ends are retained by two bolts and nuts through each cap.

Pistons - The pistons are machined from an aluminum alloy. The piston pin is of a full floating type with a plug located in each end of the pin. Depending on the cylinder assembly, pistons may be machined for either three or four rings and may employ either half wedge or full wedge rings. Consult the latest revision of Service Instruction No. 1037 for proper piston and ring combinations.

Accessory Housing - The accessory housing is made from an aluminum casting and is fastened to the rear of the crankcase and the top rear of the sump. It forms a housing for the oil pump and the various accessory drives.

Oil Sump (Except -AIO Series) - The sump incorporates an oil drain plug, oil suction screen, mounting pad for carburetor or fuel injector, the intake riser and intake pipe connections.

Crankcase Covers (-AIO Series) - Crankcase covers are employed on the top and bottom of the engine. These covers incorporate oil suction screens, oil scavenge line connections. The top cover incorporates a connection for a breather line and the lower cover a connection for an oil suction line.

O-360 and ASSOCIATED MODELS**SECTION 1**

Cooling System - These engines are designed to be cooled by air pressure. Baffles are provided to build up a pressure and force the air through the cylinder fins. The air is then exhausted to the atmosphere through gills or augmentor tubes usually located at the rear of the cowling.

Induction System - Avco Lycoming O-360 and HO-360 series engines are equipped with either a float type or pressure type carburetor. See Table 1 for model application. Particularly good distribution of the fuel-air mixture to each cylinder is obtained through the center zone induction system, which is integral with the oil sump and is submerged in oil, insuring a more uniform vaporization of fuel and aiding in cooling the oil in the sump. From the riser the fuel-air mixture is distributed to each cylinder by individual intake pipes.

Avco Lycoming IO-360, AIO-360, HIO-360 and TIO-360 series engines are equipped with a Bendix type RSA fuel injector, with the exception of model IO-360-B1A which is equipped with a Simmonds type 530 fuel injector. (See Table 1 for model application.) The fuel injection system schedules fuel flow in proportion to air flow and fuel vaporization takes place at the intake ports. A turbocharger is mounted as an integral part of the TIO-360 series engines. Automatic waste gate control of the turbocharger provides constant air density to the fuel injector inlet from seal level to critical altitude.

A brief description of the carburetors and fuel injectors follows:

The Marvel-Schebler MA-4-5 and HA-6 carburetors are of the single barrel float type equipped with a manual mixture control and an idle cut-off.

The Marvel-Schebler MA-4-5AA carburetor is of the single barrel float type with automatic pressure altitude mixture control. This carburetor is equipped with idle cut-off but does not have a manual mixture control.

The Bendix-Stromberg PSH-5BD is a pressure operated, single barrel horizontal carburetor, incorporating an airflow operated power enrichment valve and an automatic mixture control unit. It is equipped with an idle cut-off and a manual mixture control. The AMC unit works independently of, and in parallel with, the manual mixture control.

SECTION 1**O-360 and ASSOCIATED MODELS**

The Bendix RSA type fuel injection system is based on the principle of measuring air flow and using the air flow signal in a stem type regulator to convert the air force into a fuel force. This fuel force (fuel pressure differential) when applied across the fuel metering section (jetting system) makes fuel flow proportional to air flow.

The Simmonds type 530 is a continuous flow fuel injection system. This continuous flow system has three separate components:

1. A fuel pump assembly.
2. A throttle body assembly.
3. Four fuel flow nozzles.

This system is throttle actuated. Fuel is injected into the engine intake valve ports by the nozzles. The system continuously delivers metered fuel to each intake valve port in response to throttle position, engine speed and mixture control position. Complete flexibility of operation is provided by the manual mixture control which permits the adjustment of the amount of injected fuel to suit all operating conditions. Moving the mixture control to "Idle Cut-Off" results in a complete cut-off of fuel to the engine.

Lubrication System - (All models except AIO-360 series). The full pressure wet sump lubrication system is actuated by an impeller type pump contained within the accessory housing.

(AIO-360 series). The AIO-360 series is designed for aerobatic flying and is of the dry sump type. A double scavenge pump is installed on the accessory housing.

Priming System - Provision for a primer system is provided on all engines employing a carburetor. Fuel injected engines do not require a priming system.

Ignition System - Dual ignition is furnished by two Bendix magnetos. Consult Table 1 for model application.

Counterweight System - Models designated by the numeral 6 in the suffix of the model number (example: O-360-A1G6) are equipped with crankshafts with pendulum type counterweights attached.

TABLE 1

MODEL APPLICATION			
Model	Magneto*		Carburetor
	Left	Right	
O-360			
-A1A, -A2A, -A3A, -A4A	S4LN-21	S4LN-20	MA-4-5
-A1C, -C2D	S4LN-200	S4LN-204	PSH-5BD
-A1D, -A2D, -A3D, -A2E	S4LN-200	S4LN-204	MA-4-5
-A1F, -A2F, -A1F6	S4LN-1227	S4LN-1209	MA-4-5
-A1G, -A2G, -A4G, -A1G6	S4LN-1227	S4LN-1209	HA-6
-A1H, -A2H, -A4J	S4LN-21	S4LN-204	HA-6
-A4K	4051	4050	HA-6
-B1A, -B2A, -C1A, -C2A	S4LN-21	S4LN-20	MA-4-5
-B1B, -B2B, -C1C, -C2C	S4LN-200	S4LN-204	MA-4-5
-C2B	S4LN-21	S4LN-20	PSH-5BD
-D1A, -D2A	S4LN-21	S4LN-20	MA-4-5
-D2B	S4LN-200	S4LN-204	MA-4-5
-C1E, -C2E, -A4M	4051	4050	MA-4-5
-A1AD, -A3AD, -A5AD	D4LN-2021		MA-4-5
-A1F6D, -A1LD	D4LN-2021		MA-4-5
-A1G6D	D4LN-2021		HA-6
HO-360			
-A1A	S4LN-200	S4LN-204	MA-4-5AA
-B1A	S4LN-200	S4LN-204	PSH-5BD
-B1B	S4LN-200	S4LN-200	PSH-5BD
HIO-360			Fuel Injector
-A1A, -B1A, -B1B	S4LN-200	S4LN-200	RSA-5AB1
-C1A	S4LN-200	S4LN-204	RSA-5AB1
-C1B	S4LN-1208	S4LN-1209	RSA-5AB1
-D1A	S4LN-1208	S4LN-1208	RSA-7AA1
-E1AD	D4LN-2021		RSA-5AD1

*Models with counter-clockwise rotation employ S4RN series.

Engine models with letter "D" as 4th or 5th character in suffix denotes dual magnetos in single housing. Basic models employing -21 or -1227 (impulse coupling magnetos) use D4LN or D4RN-2021. Basic models employing -200 and -1208 (retard breaker magnetos) use D4LN or D4RN-2200. Example - Basic model IO-360-C1C uses S4LN-1227 and S4LN-1209, therefore model IO-360-C1CD would employ S4LN-2021.

SECTION 1
O-360 and ASSOCIATED MODELS
TABLE 1 (CONT.)

MODEL APPLICATION			
Model	Magnetos		Fuel Injector
	Left	Right	
IO-360			
-A1A, -A2A, -B1B, -B1C	S4LN-200	S4LN-204	RSA-5 AD1
-A1B, -A2B, -A1B6	S4LN-1227	S4LN-1209	RSA-5 AD1
-A1C, -A2C, -C1B, -F1A	S4LN-1208	S4LN-1209	RSA-5 AD1
-A1D6, -B1E, -B2E	S4LN-1227	S4LN-1209	RSA-5 AD1
-B1A	S4LN-200	S4LN-204	530
-B1D, -C1A	S4LN-200	S4LN-204	RSA-5 AD1
-B1F, -B2F, -B2F6	S4LN-1227	S4LN-1227	RSA-5 AD1
-B4A	S4LN-21	S4LN-20	RSA-5 AD1
-C1C, -C1C6, -C1D6	S4LN-1227	S4LN-1209	RSA-5 AD1
-C1E6, -C1F	S4LN-1227	S4LN-1209	RSA-5 AD1
-D1A, -E1A	S4LN-1208	S4LN-1209	RSA-5 AD1
-A1D	S4LN-21	S4LN-204	RSA-5 AD1
-A1B6D, -A3B6D	D4LN-2021		RSA-5 AD1
AIO-360			
-A1A, -A2A	S4LN-1208	S4LN-1209	RSA-5 AD1
-A1B, -A2B, -B1B	S4LN-1227	S4LN-1209	RSA-5 AD1
TIO-360			
-A1A, -A1B, -A3B6	S4LN-1208	S4LN-1209	RSA-5 AD1

*Models with counter-clockwise rotation employ S4RN series.

SPECIFICATIONS

	Page
Specifications	
O-360-A, -B, -C, -D2-1
HO-360-A, -B2-2
IO-360-A, -B, -C, -D, -E, -F2-3
AIO-360-A, -B2-4
HIO-360-A, -B2-4
HIO-360-C, -D2-5
TIO-360-A; HIO-360-E2-6
Accessory Drives2-7
Detail Weights	
Engines2-8
Dimensions2-9

SECTION 2

SPECIFICATIONS

O-360-A, -C SERIES*

FAA Type Certificate	286
Rated horsepower	180
Rated speed, RPM	2700
Bore, inches	5.125
Stroke, inches	4.375
Displacement, cubic inches	361.0
Compression ratio	8.5:1
Firing order	1-3-2-4
Spark occurs, degrees BTC	25
Valve rocker clearance (hydraulic tappets collapsed)028-.080
Propeller drive ratio1:1
Propeller drive rotation (viewed from rear)Clockwise

*O-360-C2D only. Take-off rating 180 HP @ 2900 RPM and 28 in. hg.

SPECIFICATIONS

O-360-B, -D SERIES

FAA Type Certificate	286
Rated horsepower	168
Rated speed, RPM	2700
Bore, inches	5.125
Stroke, inches	4.375
Displacement, cubic inches	361.0
Compression ratio	7.2:1
Firing order	1-3-2-4
Spark occurs, degrees BTC	25
Valve rocker clearance (hydraulic tappets collapsed)028-.080
Propeller drive ratio1:1
Propeller drive rotation (viewed from rear)Clockwise

SECTION 2**O-360 and ASSOCIATED MODELS****SPECIFICATIONS****HO-360-A SERIES**

FAA Type Certificate	286
Rated horsepower	180
Rated speed, RPM	2700
Bore, inches	5.125
Stroke, inches	4.375
Displacement, cubic inches	361.0
Compression ratio	8.5:1
Firing order	1-3-2-4
Spark occurs, degrees BTC	25
Valve rocker clearance (hydraulic tappets collapsed)028-.080
Propeller drive ratio	1:1
Propeller drive rotation (viewed from rear)	Clockwise

SPECIFICATIONS**HO-360-B SERIES**

FAA Type Certificate	286
Rated horsepower	180
Rated speed, RPM	2900
Bore, inches	5.125
Stroke, inches	4.375
Displacement, cubic inches	361.0
Compression ratio	8.5:1
Firing order	1-3-2-4
Spark occurs, degrees BTC	25
Valve rocker clearance (hydraulic tappets collapsed)028-.080
Propeller drive ratio	1:1
Propeller drive rotation (viewed from rear)	Clockwise

O-360 and ASSOCIATED MODELS

SECTION 2

SPECIFICATIONS

IO-360-A, -C, -D SERIES

FAA Type Certificate	1E10
Rated horsepower	200
Rated speed, RPM	2700
Bore, inches	5.125
Stroke, inches	4.375
Displacement, cubic inches	361.0
Compression ratio	8.7:1
Firing order	1-3-2-4
Spark occurs, degrees BTC	25**
Valve rocker clearance (hydraulic tappets collapsed)028-.080
Propeller drive ratio	1:1
Propeller drive rotation (viewed from rear)	Clockwise

SPECIFICATIONS

IO-360-B, -E, -F SERIES*

FAA Type Certificate	1E10
Rated horsepower	180
Rated speed, RPM	2700
Bore, inches	5.125
Stroke, inches	4.375
Displacement, cubic inches	361.0
Compression ratio	8.5:1
Firing order	1-3-2-4
Spark occurs, degrees BTC	25
Valve rocker clearance (hydraulic tappets collapsed)028-.080
Propeller drive ratio	1:1
Propeller drive rotation (viewed from rear)	Clockwise

* - IO-360-B1C only. Rated @ 177 HP.

****NOTE**

On the following model engines, the magneto spark occurs at 20° BTC. Consult nameplate before timing magnetos.

Models

Serial No.

IO-360-A Series (Except -A1B6D)	L-14436-51 and up
IO-360-C, -D Series (Except -C1C, -C1F, -C1C6, -C1D6)	L-14436-51 and up
IO-360-C1C, -C1F	L-13150-51 and up
IO-360-C1D6	L-14446-51 and up
L1O-360-C1E6	L-1064-67 and up
A1O-360-A1A, -A1B, -B1B	L-220-63 and up
H1O-360-C1A, -C1B	L-14436-51 and up
IO-360-C1C6	All Engines

SECTION 2**O-360 and ASSOCIATED MODELS****SPECIFICATIONS****AIO-360-A, -B SERIES**

FAA Type Certificate	1E10
Rated horsepower	200
Rated speed, RPM	2700
Bore, inches	5.125
Stroke, inches	4.375
Displacement, cubic inches	361.0
Compression ratio	8.7:1
Firing order	1-3-2-4
Spark occurs, degrees BTC	25**
Valve rocker clearance (hydraulic tappets collapsed)028-.080
Propeller drive ratio	1:1
Propeller drive rotation (viewed from rear)	Clockwise

SPECIFICATIONS**HIO-360-A, -B SERIES**

FAA Type Certificate	1E10
Rated horsepower	180*
Rated speed, RPM	2900
Bore, inches	5.125
Stroke, inches	4.375
Displacement, cubic inches	361.0
Compression ratio, -A series	8.7:1
Compression ratio, -B Series	8.5:1
Firing order	1-3-2-4
Spark occurs, degrees BTC	25
Valve rocker clearance (hydraulic tappets collapsed)028-.080
Propeller drive ratio	1:1
Propeller drive rotation (viewed from rear)	Clockwise

* - HIO-360-A has a rating of 180 HP at 26.1 in. Hg. manifold at standard sea level conditions to 3900 feet standard altitude with 25 in. Hg. manifold pressure.

** - See Note Page 2-3.

SPECIFICATIONS

HIO-360-C SERIES

FAA Type Certificate	1E10
Rated horsepower	205
Rated speed, RPM	2900
Bore, inches	5.125
Stroke, inches	4.375
Displacement, cubic inches	361.0
Compression ratio	8.7:1
Firing order	1-3-2-4
Spark occurs, degrees BTC25**
Valve rocker clearance (hydraulic tappets collapsed)028-.080
Propeller drive ratio1:1
Propeller drive rotation (viewed from rear)Clockwise

SPECIFICATIONS

HIO-360-D SERIES

FAA Type Certificate	1E10
Rated horsepower	190
Rated speed, RPM	3200
Bore, inches	5.125
Stroke, inches	4.375
Displacement, cubic inches	361.0
Compression ratio	10.0:1
Firing order	1-3-2-4
Spark occurs, degrees BTC	20
Valve rocker clearance (hydraulic tappets collapsed)	*.028-.080
Propeller drive ratio1:1
Propeller drive rotation (viewed from rear)Clockwise

* - Consult Service Bulletin No. 402 for valve rocker clearance of HIO-360-D1A.

** - See Note Page 2-3.

SECTION 2**O-360 and ASSOCIATED MODELS****SPECIFICATIONS****TIO-360-A SERIES**

FAA Type Certificate	E16EA
Rated horsepower	200
Rated speed, RPM	2575
Bore, inches	5.125
Stroke, inches	4.375
Displacement, cubic inches	361.0
Compression ratio	7.3:1
Firing order	1-3-2-4
Spark occurs, degrees BTC	20
Valve rocker clearance (hydraulic tappets collapsed)028-.080
Propeller drive ratio	1:1
Propeller drive rotation (viewed from rear)	Clockwise

SPECIFICATIONS**HIO-360-E SERIES**

FAA Type Certificate	1E10
Rated horsepower	190
Rated speed, RPM	2900
Bore, inches	5.125
Stroke, inches	4.375
Displacement, cubic inches	361.0
Compression ratio	8.1:1
Firing order	1-3-2-4
Spark occurs, degrees BTC	20
Valve rocker clearance (hydraulic tappets collapsed)028-.080
Propeller drive ratio	1:1
Propeller drive rotation (viewed from rear)	Clockwise

HIO-360-E has a rating of 205 HP at 2900 RPM and 36.5 in. Hg. manifold pressure when equipped with turbocharger kit SK-28-121000 or equivalent.

*Accessory Drive	Drive Ratio	**Direction of Rotation
Starter	16.556:1	Counter-Clockwise
Generator	1.910:1	Clockwise
Generator	2.500:1	Clockwise
Alternator	3.250:1	Clockwise
Tachometer	0.500:1	Clockwise
Magneto	1.000:1	Clockwise
Vacuum Pump	1.300:1	Counter-Clockwise
Propeller Governor (Rear mounted)	0.866:1	Clockwise
Propeller Governor (Front mounted)	0.895:1	Clockwise
Fuel Pump AN20010	0.866:1	Counter-Clockwise
Fuel Pump AN20003	1.000:1	Counter-Clockwise
Fuel Pump - Plunger operated Dual Drives	0.500:1	
Vacuum - Hyd. pump	1.300:1	Counter-Clockwise
Vacuum - Prop. Gov.	1.300:1	Counter-Clockwise

NOTE

Engines with letter "L" in prefix will have opposite rotation to the above.

* - When applicable

** - Viewed facing drive pad

SECTION 2
O-360 and ASSOCIATED MODELS
DETAIL WEIGHTS
1. ENGINE, STANDARD, DRY WEIGHT

Includes carburetor or fuel injector, magnetos, spark plugs, ignition harness, intercylinder baffles, tachometer drive, starter and generator or alternator drive, starter and generator or alternator with mounting bracket. Turbocharged models include turbocharger, mounting bracket, exhaust manifold, controls, oil lines and baffles.

Model	Lbs.
O-360-D1A, -D2A, -D2B	282.00
O-360-B1A, -B2A, -B1B, -B2B	284.00
O-360-A1D, -A2D, -A3D, -A2E, -C1A, -C2A, -C1E, -C2E; HO-360-A1A	285.00
O-360-A1A, -A2A, -A3A, -A1F, -A2F, -C1C, -C2C	286.00
O-360-A1AD, -A3AD	288.00
O-360-A1C, -C2B, -C2D; HO-360-B1A, -B1B; IO-360-B1C	289.00
HO-360-B1A, -B1B; O-360-A1LD	290.00
O-360-A4A, -A1F6, -A1G, -A2G, -A1H, -A2H, -A4M; IO-360-B1D	294.00
O-360-A1F6D	295.00
O-360-A4K, -A5AD; IO-360-B1A, -B1B, -B1E, -B2A, -E1A	296.00
O-360-A1G6D	297.00
IO-360-B1F, -B2F	298.00
O-360-A4G, -A4J, -A1G6	301.00
IO-360-B4A, -F1A	304.00
IO-360-B2F6	308.00
HIO-360-A1A	311.00
IO-360-C1A; HIO-360-D1A, -E1AD	321.00
IO-360-A1A, -A2A, -C1B, -D1A; HIO-360-C1A, -C1B	323.00
IO-360-C1F	324.00
IO-360-A1B, -A2B, -A1C, -A2C	325.00
IO-360-C1C, -C1C6, -C1D6	329.00
IO-360-A1B6D; A3B6D	330.00
IO-360-A1D6; AIO-360-A1A, -A2A	331.00
IO-360-A1B6; AIO-360-A1B, -A2B, -B1B	332.00
TIO-360-A1A, -A1B	386.00

DIMENSIONS, INCHES			
MODEL	HEIGHT	WIDTH	LENGTH
O-360			
-A4M	25.59	33.37	29.05
-A1A, -A2A	24.59	33.37	29.56
-A3A, -A4A	24.59	33.37	29.56
-A1C	19.68	33.37	30.67
-C1E, -C2E	24.59	33.37	29.05
-A1D, -A2D	24.59	33.37	29.81
-A3D, -A2E	24.59	33.37	29.81
-A1F, -A2F	24.59	33.37	30.70
-A1F6	24.59	33.37	30.70
-A1G, -A2G	19.22	33.37	31.82
-A4K, -A1G6D	19.22	33.37	31.82
-A4G, -A4J	19.22	33.37	31.82
-A1H, -A2H	19.22	33.37	31.82
-B1A, -B2A	24.68	33.37	29.56
-B1B, -B2B	24.68	33.37	29.81
-C1A, -C2A	24.72	33.37	29.56
-C1C, -C2C	24.59	33.37	29.81
-C2B, -C2D	19.68	33.37	30.67
-D1A, -D2A	24.59	33.37	29.56
-D2B	24.59	33.37	29.81
-A1AD, -A3AD	24.59	33.37	31.33
-A1A5D, -A1F6D	24.59	33.37	31.33
-A1LD	24.59	33.37	31.33
HO-360			
-A1A	24.59	33.37	29.81
-B1A, -B1B	19.68	33.37	30.67
IO-360			
-A1A, -A2A	19.35	34.25	29.81
-A1B, -A2B	19.35	34.25	30.70
-A1B6	19.35	34.25	30.70
-A1C, -A2C	19.35	34.25	30.70
-A1D6	19.35	34.25	30.70
-A1B6D, -A3B6D	19.35	34.25	31.33



DIMENSIONS, INCHES (CONT.)

MODEL	HEIGHT	WIDTH	LENGTH
IO-360 (Cont.)			
-B1A	22.47	33.37	32.81
-B1B, -B1D	24.84	33.37	29.81
-B1C	20.70	33.37	30.68
-B1E, -B2E	20.70	33.37	32.09
-B1F, -B2F, -B2F6	24.84	33.37	30.70
-B4A	24.84	33.37	29.56
-C1A, -C1B	19.48	34.25	31.14
-C1C, -C1C6	19.48	34.25	33.65
-C1E6, -C1F	19.48	34.25	33.65
-D1A	19.48	34.25	31.14
-E1A, -F1A	20.70	33.37	32.09
AIO-360			
-A1A, -A2A	20.76	34.25	30.08
-A1B, -A2B	20.76	34.25	30.08
-B1B	20.76	34.25	30.08
HIO-360			
-A1A	19.48	35.25	33.65
-B1A	19.38	33.37	32.09
-B1B	19.38	33.37	30.68
-C1A, -C1B	19.48	34.25	31.14
-D1A	19.48	35.25	35.28
-E1AD	19.97	34.25	31.36
TIO-360			
-A1A	21.43	34.25	45.41
-A1B	19.92	34.25	45.41

OPERATING INSTRUCTIONS

	Page
General	3-1
Prestarting Items of Maintenance	3-1
Starting Procedures	3-2
Cold Weather Starting	3-4
Ground Running and Warm-Up	3-4
Ground Check	3-4
Operation in Flight	3-6
Engine Flight Chart	3-12
Operating Conditions	3-13
Shut Down Procedure	3-17
Performance Curves	3-18

SECTION 3**OPERATING INSTRUCTIONS**

1. **GENERAL.** Close adherence to these instructions will greatly contribute to long life, economy and satisfactory operation of the engine.

NOTE

YOUR ATTENTION IS DIRECTED TO THE WARRANTIES THAT APPEAR IN THE FRONT OF THIS MANUAL REGARDING ENGINE SPEED, THE USE OF SPECIFIED FUELS AND LUBRICANTS, REPAIRS AND ALTERATIONS. PERHAPS NO OTHER ITEM OF ENGINE OPERATION AND MAINTENANCE CONTRIBUTES QUITE SO MUCH TO SATISFACTORY PERFORMANCE AND LONG LIFE AS THE CONSTANT USE OF CORRECT GRADES OF FUEL AND OIL, CORRECT ENGINE TIMING, AND FLYING THE AIRCRAFT AT ALL TIMES WITHIN THE SPEED AND POWER RANGE SPECIFIED FOR THE ENGINE. DO NOT FORGET THAT VIOLATION OF THE OPERATION AND MAINTENANCE SPECIFICATIONS FOR YOUR ENGINE WILL NOT ONLY VOID YOUR WARRANTY BUT WILL SHORTEN THE LIFE OF YOUR ENGINE AFTER ITS WARRANTY PERIOD HAS PASSED.

New engines have been carefully run-in by Avco Lycoming and therefore, no further break-in is necessary insofar as operation is concerned; however, new or newly overhauled engines should be operated on straight mineral oil for a minimum of 50 hours or until oil consumption has stabilized. After this period, a change to an approved additive oil may be made, if so desired.

NOTE

Cruising should be done at 65% to 75% power until a total of 50 hours has accumulated or oil consumption has stabilized. This is to ensure proper seating of the rings and is applicable to new engines, and engines in service following cylinder replacement or top overhaul of one or more cylinders.

The minimum fuel octane rating is listed in the flight chart, Part 8 of this section. Under no circumstances should fuel of a lower octane rating or automotive fuel (regardless of octane rating) be used.

2. **PRESTARTING ITEMS OF MAINTENANCE.** Before starting the aircraft engine for the first flight of the day, there are several items of maintenance inspection that should be performed. These are described in Section 4 under Daily Pre-Flight Inspection. They must be observed before the engine is started.

SECTION 3**O-360 and ASSOCIATED MODELS****3. STARTING PROCEDURES - O-360, HO-360, IO-360, AIO-360, HIO-360, TIO-360 Series.**

The following starting procedures are recommended, however, the starting characteristics of various installations will necessitate some variation from these procedures.

a. Engines Equipped with Float Type Carburetors.

- (1) Perform pre-flight inspection.
- (2) Set carburetor heat control in "off" position.
- (3) Set propeller governor control in "Full RPM" position (where applicable).
- (4) Turn fuel valves "On".
- (5) Move mixture control to "Full Rich".
- (6) Turn on boost pump.
- (7) Open throttle approximately 1/4 travel.
- (8) Prime with 1 to 3 strokes of manual priming pump or activate electric primer for 1 or 2 seconds.
- (9) Set magneto selector switch (consult airframe manufacturer's handbook for correct position).
- (10) Engage starter.
- (11) When engine fires move the magneto switch to "Both".
- (12) Check oil pressure gage. If minimum oil pressure is not indicated within thirty seconds, stop engine and determine trouble.

b. Engines Equipped with Pressure Carburetors or Bendix Fuel Injectors.

- (1) Perform pre-flight inspection.
- (2) Set carburetor heat or alternate air control in "off" position.

(3) Set propeller governor control in "Full RPM" position (where applicable).

(4) Turn fuel valve "On".

(5) Open throttle approximately 1/4 travel.

(6) Turn boost pump "On".

(7) Move mixture control to "Full Rich" until a slight but steady fuel flow is noted (approximately 3 to 5 seconds) and return mixture control to "Idle Cut-Off".

(8) Set magneto selector switch (consult airframe manufacturer's handbook for correct position).

(9) Engage starter.

(10) When engine fires move the magneto switch to "Both".

(11) Move mixture control slowly and smoothly to "Full Rich".

(12) Check oil pressure gage. If minimum oil pressure is not indicated within thirty seconds, stop engine and determine trouble.

c. Engines Equipped with Simmonds Type 530 Fuel Injector.

(1) Perform pre-flight inspection.

(2) Set alternate air control in "off" position.

(3) Set propeller governor control in "Full RPM" position.

(4) Turn fuel valve "On".

(5) Move mixture control to "Full Rich".

(6) Open throttle approximately 1/4 travel.

(7) Turn on boost pump.

(8) Move combination magneto switch to "Start", using accelerator pump as a primer while cranking engine.

(9) When engine fires allow the switch to return to "Both".

(10) Check oil pressure gage. If minimum oil pressure is not indicated within thirty seconds, stop engine and determine trouble.

SECTION 3**O-360 and ASSOCIATED MODELS**

4. COLD WEATHER STARTING. During extreme cold weather, it may be necessary to preheat the engine and oil before starting.

5. GROUND RUNNING AND WARM-UP.

The engines covered in this manual are air-pressure cooled and depend on the forward speed of the aircraft to maintain proper cooling. Particular care is necessary, therefore, when operating these engines on the ground. To prevent overheating, it is recommended that the following precautions be observed.

NOTE

Any ground check that requires full throttle operation must be limited to three minutes, or less if the cylinder head temperatures should exceed the maximum as stated in this manual.

a. Fixed Wing.

- (1) Head the aircraft into the wind.
- (2) Leave mixture in "Full Rich".
- (3) Operate only with the propeller in minimum blade angle setting.
- (4) Warm-up to approximately 1000-1200 RPM. Avoid prolonged idling and do not exceed 2200 RPM on the ground.
- (5) Engine is warm enough for take-off when the throttle can be opened without the engine faltering. Take-off with a turbocharged engine should not be started if indicated lubricating oil pressure, due to cold temperature is above maximum. Excessive oil pressure can cause overboost and consequent engine damage.

b. Helicopter.

- (1) Warm-up at approximately 2000 RPM with rotor engaged as directed in the airframe manufacturer's handbook.

6. GROUND CHECK.

- a. Warm up as directed above.
- b. Check both oil pressure and oil temperature.
- c. Leave mixture control in "Full Rich".

d. Fixed Wing Aircraft (where applicable). Move the propeller control through its complete range to check operation and return to full low pitch position. Full feathering check (twin engine) on the ground is not recommended but the feathering action can be checked by running the engine between 1000 - 1500 RPM, then momentarily pull the propeller control into the feathering position. Do not allow the RPM to drop more than 500 RPM.

e. A proper magneto check is important. Additional factors, other than the ignition system, affect magneto drop-off. They are load-power output, propeller pitch, and mixture strength. The important thing is that the engine runs smoothly because magneto drop-off is affected by the variables listed above. Make the magneto check in accordance with the following procedures:

(1) Fixed Wing Aircraft.

(Controllable pitch propeller). With propeller in minimum pitch angle, set the engine to produce 50 - 65% power as indicated by manifold pressure gage. At these settings, the ignition system and spark plugs must work harder because of the greater pressure within the cylinders. Under these conditions, ignition problems, if they exist, will occur. Magneto checks at low power settings will only indicate fuel/air distribution quality.

(Fixed pitch propeller). Aircraft that are equipped with fixed pitch propellers, or not equipped with manifold pressure gage, may check magneto drop-off with engine operating at approximately 1800 RPM (2000 RPM maximum).

Switch from both magnetos to one and note drop-off, return to both until engine regains speed and switch to the other magneto and note drop-off. Drop-off should not exceed 175 RPM. Drop-off between magnetos should not exceed 50 RPM. A smooth drop-off past normal is usually a sign of a too lean or too rich mixture.

(2) Helicopter.

Raise collective pitch stick to obtain 15 inches manifold pressure at 2000 RPM.

Switch from both magnetos to one and note drop-off, return to both until engine regains speed and switch to the other magneto and note drop-off. Drop-off should not exceed 200 RPM. Drop-off between magnetos should not exceed 50 RPM. A smooth drop-off past normal is usually a sign of a too lean or too rich mixture.

f. Do not operate on a single magneto for too long a period, a few seconds is usually sufficient to check drop-off and will minimize plug fouling.

SECTION 3**O-360 and ASSOCIATED MODELS****7. OPERATION IN FLIGHT.**

a. See airframe manufacturer's instructions for recommended power settings.

b. Move the controls slowly and smoothly. In particular, avoid rapid opening and closing of the throttle on engines with counterweighted crankshafts. There is a possibility of detuning the counterweights with subsequent engine damage.

c. Fuel Mixture Leaning Procedure.

Improper fuel/air mixture during flight is responsible for engine problems, particularly during take-off and climb power settings. The procedures described in this manual provide proper fuel/air mixture when leaning Avco Lycoming engines; they have proven to be both economical and practical by eliminating excessive fuel consumption and reducing damaged parts replacement. It is therefore recommended that operators, of all Avco Lycoming aircraft power-plants, utilize the instructions in this publication any time the fuel/air mixture is adjusted during flight.

Manual leaning may be monitored by exhaust gas temperature indication, fuel flow indication, and by observation of engine speed and/or airspeed. However, whatever instruments are used in monitoring the mixture, the following general rules should be observed by the operator of Avco Lycoming aircraft engines.

GENERAL RULES

Never exceed the maximum red line cylinder head temperature limit.

For maximum service life, cylinder head temperatures should be maintained below 435°F. (224°C.) during high performance cruise operation and below 400°F. (205°C.) for economy cruise powers.

Do not manually lean engines equipped with automatically controlled fuel system.

On engines with manual mixture control, maintain mixture control in "Full Rich" position for rated take-off, climb and maximum cruise powers (above approximately 75%). However, during take-off from high elevation airport or during climb, roughness or loss of power may result from over-richness. In such a case adjust mixture control only enough to obtain smooth operation - not for economy. Observe instruments for temperature rise. Rough operation due to over-rich fuel/air mixture is most likely to be encountered in carbureted engines at altitude above 5,000 feet.

Always return the mixture to full rich before increasing power settings.

Operate the engine at maximum power mixture for performance cruise powers and at best economy mixture for economy cruise power; unless otherwise specified in the airplane owners manual.

During let-down flight operations it may be necessary to manually lean uncompensated carbureted or fuel injected engines to obtain smooth operation.

On turbocharged engines never exceed 1650°F. turbine inlet temperature (TIT).

1. LEANING TO EXHAUST GAS TEMPERATURE GAGE.

a. Normally aspirated engines with fuel injectors or uncompensated carburetors.

(1) Maximum Power Cruise (approximately 75% power) - Never lean beyond 150°F. on rich side of peak EGT unless aircraft operator's manual shows otherwise. Monitor cylinder head temperatures.

(2) Best Economy Cruise (approximately 75% power and below) - Operate at peak EGT.

b. Turbocharged engines.

(1) Best Economy Cruise - Lean to peak turbine inlet temperature (TIT) or 1650°F., whichever occurs first.

SECTION 3
O-360 and ASSOCIATED MODELS

Figure 3-1. Representative Effect of Fuel/Air Ratio on Cylinder Head Temperature, Power and Specific Fuel Consumption at Constant RPM and Manifold Pressure in Cruise Range Operation

(2) *Maximum Power Cruise* - The engine must always be operated on the rich side of peak EGT or TIT. Before leaning to obtain maximum power mixture it is necessary to establish a reference point. This is accomplished as follows:

- (a) Establish a peak EGT or TIT for best economy operation at the highest economy cruise power without exceeding 1650°F.
- (b) Deduct 125°F. from this temperature and thus establish the temperature reference point for use when operating at maximum power mixture.
- (c) Return mixture control to full rich and adjust the RPM and manifold pressure for desired performance cruise operation.
- (d) Lean out mixture until EGT or TIT is the value established in Step b. This sets the mixture at best power.

2. LEANING TO FLOWMETER.

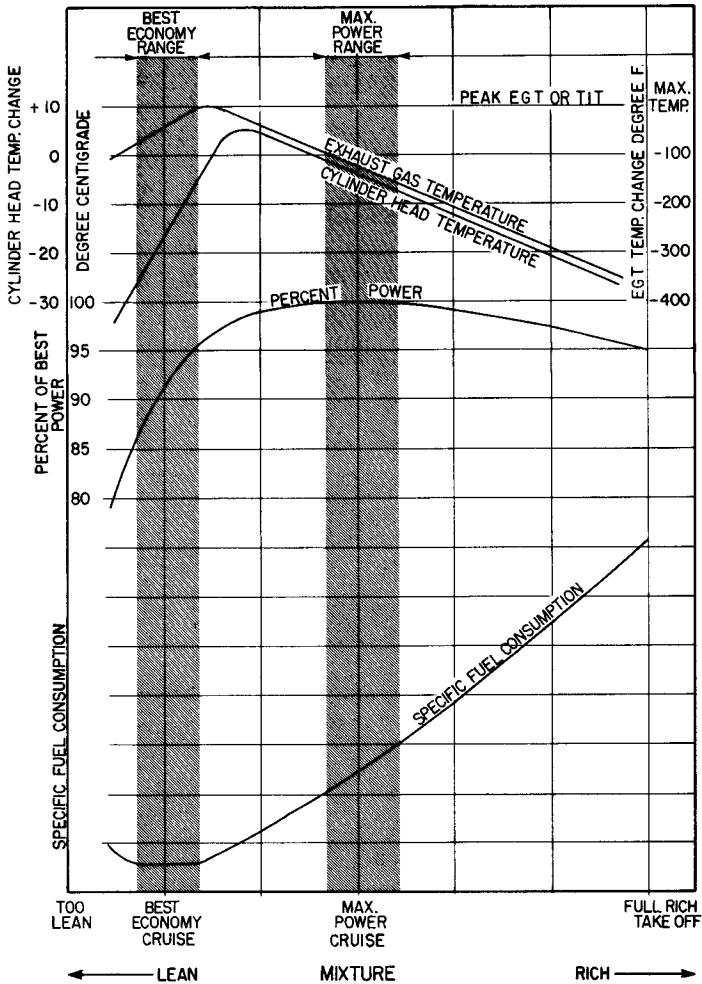
Lean to applicable fuel-flow tables or lean to indicator marked for correct fuel flow for each power setting.

3. LEANING WITH MANUAL MIXTURE CONTROL. (Economy cruise, 75% power or less) without flowmeter or EGT gage.)

a. Carbureted Engines.

- (1) Slowly move mixture control from "Full Rich" position toward lean position.
- (2) Continue leaning until engine roughness is noted.
- (3) Enrich until engine runs smoothly and power is regained.

b. Fuel Injected Engines.

- (1) Slowly move mixture control from "Full Rich" position toward lean position.
- (2) Continue leaning until slight loss of power is noted (loss of power may or may not be accompanied by roughness).
- (3) Enrich until engine runs smoothly and power is regained.

c. Use of Carburetor Heat Control - Under certain moist atmospheric conditions at temperatures of 20° to 90°, it is possible for ice to form in the induction system, even in summer weather. This is due to the high air velocity through the carburetor venturi and the absorption of heat from this air by vaporization of the fuel. The temperature in the mixture chamber may drop as much as 70°F. below the temperature of the incoming air. If this air contains a large amount of moisture, the cooling process can cause precipitation in the form of ice. Ice formation generally begins in the vicinity of the butterfly and may build up to such an extent that a drop in power output could result. A loss of power is reflected by a drop in manifold pressure in installations equipped with constant speed propellers and a drop in manifold pressure and RPM in installations equipped with fixed pitch propellers. If not corrected, this condition may cause complete engine stoppage.

To avoid this, all installations are equipped with a system for preheating the incoming air supply to the carburetor. In this way sufficient heat is added to replace the heat loss of vaporization of fuel, and the mixing chamber temperature cannot drop to the freezing point of water. This air preheater is essentially a tube or jacket through which the exhaust pipe from one or more cylinders is passed, and the air flowing over these surfaces is raised to the required temperature before entering the carburetor. Consistently high temperatures are to be avoided because of a loss in power and a decided variation of mixture. High charge temperatures also favor detonation and preignition, both of which are to be avoided if normal service life is to be expected from the engine. The following outline is the proper method of utilizing the carburetor heat control.

(1) Ground Operation - Use of the carburetor air heat on the ground must be held to an absolute minimum. On some installations the air does not pass through the air filter, and dirt and foreign substances can be taken into the engine with the resultant cylinder and piston ring wear. Carburetor air heat should be used on the ground only to make certain it is functioning properly.

(2) Take-Off - Take-offs and full throttle operation should be made with carburetor heat in full cold position. The possibility of expansion or throttle icing at wide throttle openings is very remote, so remote in fact, that it can be disregarded.

(3) *Climbing* - When climbing at part throttle power settings of 80% or above, the carburetor heat control should be set in the full cold position; however, if it is necessary to use carburetor heat to prevent icing it is possible for engine roughness to occur due to the over-rich fuel/air mixture produced by the additional carburetor heat. When this happens, carefully lean the mixture with the mixture control only enough to produce smooth engine operation. Do not continue to use carburetor heat after flight is out of icing conditions, and return mixture to full rich when carburetor heat is removed.

(4) *Flight Operation* - During normal flight, leave the carburetor air heat control in the cold position. On damp, cloudy, foggy or hazy days, regardless of the outside air temperatures, look out for loss of power. This will be evidenced by an unaccountable loss in manifold pressure or RPM or both, depending on whether a constant speed or fixed pitch propeller is installed on the aircraft. If this happens, apply full carburetor air heat and open the throttle to limiting manifold pressure and RPM. This will result in a slight additional drop in manifold pressure which is normal, and this drop will be regained as the ice is melted out of the induction system. When ice has been melted from the induction system, the carburetor heat control should be returned to the cold position. In those aircraft equipped with a carburetor air temperature gage, partial heat may be used to keep the mixture temperature above freezing point (32°F.).

WARNING

Caution must be exercised when operating with partial heat on aircraft that do not have a carburetor air temperature gage. It is advisable, to use either full heat or no heat in aircraft that are not equipped with a carburetor air temperature gage.

(5) *Landing Approach* - In making a landing approach, the carburetor heat should generally be in the "Full Cold" position. However, if icing conditions are suspected, the "Full Heat" should be applied. In the case that full power need be applied under these conditions, as for an aborted landing, the carburetor heat should be returned to "Full Cold" after full power application. See the aircraft flight manual for specific instructions.

SECTION 3
O-360 and ASSOCIATED MODELS
8. ENGINE FLIGHT CHART
FUEL AND OIL

Model	Aviation Grade Fuel Minimum Octane
O-360-A, -C Series	91/96 or 100/130
O-360-B, -D Series	80/87
IO-360-A, -C, -D, -F Series	100/130
IO-360-B, -E Series	91/96 or 100/130
HO-360-A, -B Series	91/96 or 100/130
AIO-360-A, -B Series	100/130
HIO-360-A, -C, -D, -E Series	100/130
HIO-360-B Series	91/96 or 100/130
TIO-360-A Series	100/130

NOTE

Aviation grade 100LL fuels in which the lead content is limited to 2 c. c. per gal. are approved for continuous use in the above listed engines.

Fuel Pressure, psi

Model	Max.	Desired	Min.
O-360 Series (Except -A1C, -C2B, -C2D)			
HO-360-A Series			
Inlet to carburetor	8.0	3.0	0.5
O-360-A1C, -C2B, -C2D, HO-360-B Series			
Inlet to carburetor	18	13	9.0
IO-360 Series (Except -B1A, -F1A)			
AIO-360 Series, HIO-360 Series			
Inlet to fuel pump	35	----	-2
IO-360-F1A			
Inlet to fuel pump	45	----	-4
IO-360 Series (Except -B1A), AIO Series, HIO Series			
Inlet to fuel injector	45		14
IO-360-B1A			
Inlet to fuel injector	2		-2
TIO-360 Series			
Inlet to fuel pump	50		-2
Inlet to fuel injector	45		20
HIO-360-E			
Inlet to fuel pump	55		-2
Inlet to fuel injector	55		27

ALL MODELS

***Recommended Grade Oil**

Average Ambient Air	MIL-6082 Grades	MIL-22851
		Ashless Dispersant Grades
Above 60°F.	SAE 50	SAE 40 or SAE 50
30° to 90°F.	SAE 40	SAE 40
0° to 70°F.	SAE 30	SAE 40 or SAE 30
Below 10°F.	SAE 20	SAE 30

* - Refer to the latest edition of Service Instruction No. 1014.

OIL SUMP CAPACITY

All Models (Except AIO-360 Series)	8 U. S. Quarts
Minimum Safe Quantity in Sump	2 U. S. Quarts
AIO-360 SeriesDry Sump

OPERATING CONDITIONS

Average Ambient Air	Oil Inlet Temperature		
	Desired	Minimum	Maximum
Above 60°F.	180°F. (82°C.)		245°F. (118°C.)
30° to 90°F.	180°F. (82°C.)		245°F. (118°C.)
0° to 70°F.	170°F. (77°C.)		225°F. (107°C.)
Below 10°F.	160°F. (71°C.)		210°F. (99°C.)
Oil Pressure, psi	Maximum	Minimum	Idling
Normal Operating All Models	90	60	25
Start and Warm-Up	100		

SECTION 3
O-360 and ASSOCIATED MODELS
OPERATING CONDITIONS

Operation	RPM	HP	Fuel Cons. Gal./Hr.	Max. Oil Cons. Qts./Hr.	*Max. Cyl. Head Temp.
O-360-A, -C** Series					
Normal Rated	2700	180	-----	.80	500°F.
Performance Cruise (75% Rated)	2450	135	10.5	.45	500°F.
Economy Cruise (65% Rated)	2350	117	9.0	.39	500°F.
O-360-B, -D Series					
Normal Rated	2700	168	-----	.75	500°F.
Performance Cruise (75% Rated)	2450	126	11.0	.42	500°F.
Economy Cruise (65% Rated)	2350	109	9.0	.37	500°F.
HO-360-A Series					
Normal Rated	2700	180	-----	.80	500°F.
Performance Cruise (75% Rated)	2450	135	10.5	.45	500°F.
Economy Cruise (65% Rated)	2350	117	9.0	.39	500°F.
HO-360-B Series					
Normal Rated	2900	180	-----	.80	500°F.
Performance Cruise (75% Rated)	2700	135	10.5	.45	500°F.
Economy Cruise (65% Rated)	2700	117	9.0	.39	500°F.

* - At Bayonet Location - For maximum service life of the engine maintain cylinder head temperatures between 150°F. and 400°F. during continuous operation.

** - O-360-C2D Only - Take-off rating 180 HP at 2900 RPM and 28 in. Hg.

OPERATING CONDITIONS

Operation	RPM	HP	Fuel Cons. Gal./Hr.	Max. Oil Cons. Qts./Hr.	*Max. Cyl. Head Temp.
IO-360-A, -C, -D; AIO-360 Series					
Normal Rated Performance Cruise (75% Rated)	2700	200	-----	.89	475°F.
Economy Cruise (65% Rated)	2450	150	12.3	.50	475°F.
	2350	130	9.5	.44	475°F.
IO-360-B, -E, -F Series (Except IO-360-B1C)					
Normal Rated Performance Cruise (75% Rated)	2700	180	-----	.80	500°F.
Economy Cruise (65% Rated)	2450	135	11.0	.45	500°F.
	2350	117	8.5	.39	500°F.
IO-360-B1C					
Normal Rated Performance Cruise (75% Rated)	2700	177	-----	.79	500°F.
Economy Cruise (65% Rated)	2450	133	11.0	.45	500°F.
	2350	115	8.5	.39	500°F.
HIO-360-A Series					
Normal Rated Performance Cruise (75% Rated)	2900	180 @ 26.1 in. Hg.		.80	475°F.
Economy Cruise (65% Rated)	2700	135	11.0	.45	475°F.
	2700	117	9.5	.39	475°F.

* - At Bayonet Location - For maximum service life of the engine maintain cylinder head temperatures between 150°F. and 400°F. during continuous operation.

SECTION 3
**O-360 and ASSOCIATED MODELS
OPERATING CONDITIONS**

Operation	RPM	HP	Fuel Cons. Gal./Hr.	Max. Oil Cons. Qts./Hr.	*Max. Cyl. Head Temp.
HIO-360-B Series					
Normal Rated	2900	180	-----	.80	500°F.
Performance Cruise (75% Rated)	2700	135	12.0	.45	500°F.
Economy Cruise (65% Rated)	2700	117	10.0	.39	500°F.
HIO-360-C Series					
Normal Rated	2900	205	-----	.91	475°F.
Performance Cruise (75% Rated)	2700	154	12.5	.52	475°F.
Economy Cruise (65% Rated)	2700	133	10.5	.45	475°F.
HIO-360-D Series					
Normal Rated	3200	190	-----	.85	475°F.
Performance Cruise (75% Rated)	3200	142	12.0	.48	475°F.
Economy Cruise (65% Rated)	3200	123	10.0	.41	475°F.
HIO-360-E Series					
Normal Rated	2900	190	-----	.85	475°F.
Performance Cruise (75% Rated)	2700	142	11.8	.47	475°F.
Economy Cruise (65% Rated)	2700	123	10.0	.41	475°F.
TIO-360-A Series**					
Normal Rated	2700	200	-----	.89	475°F.
Performance Cruise (75% Rated)	2450	150	14.0	.50	475°F.
Economy Cruise (65% Rated)	2350	130	10.2	.44	475°F.

* - At Bayonet Location - For maximum service life of the engine maintain cylinder head temperatures between 150°F. and 400°F. during continuous operation.

** - MAXIMUM TURBINE INLET TEMPERATURE 1650°F.

9. SHUT DOWN PROCEDURE**a. Fixed Wing**

- (1) Set propeller governor control for minimum blade angle (when applicable).
- (2) Idle until there is a decided drop in cylinder head temperature.
- (3) Move mixture control to "Idle Cut-Off".
- (4) When engine stops, turn off switches.

b. Helicopters

- (1) Idle as directed in the airframe manufacturer's handbook, until there is a decided drop in cylinder head temperature.
- (2) Move mixture control to "Idle Cut-Off".
- (3) When engine stops, turn off switches.

SECTION 3

O-360 and ASSOCIATED MODELS

CURVE NO. 10348

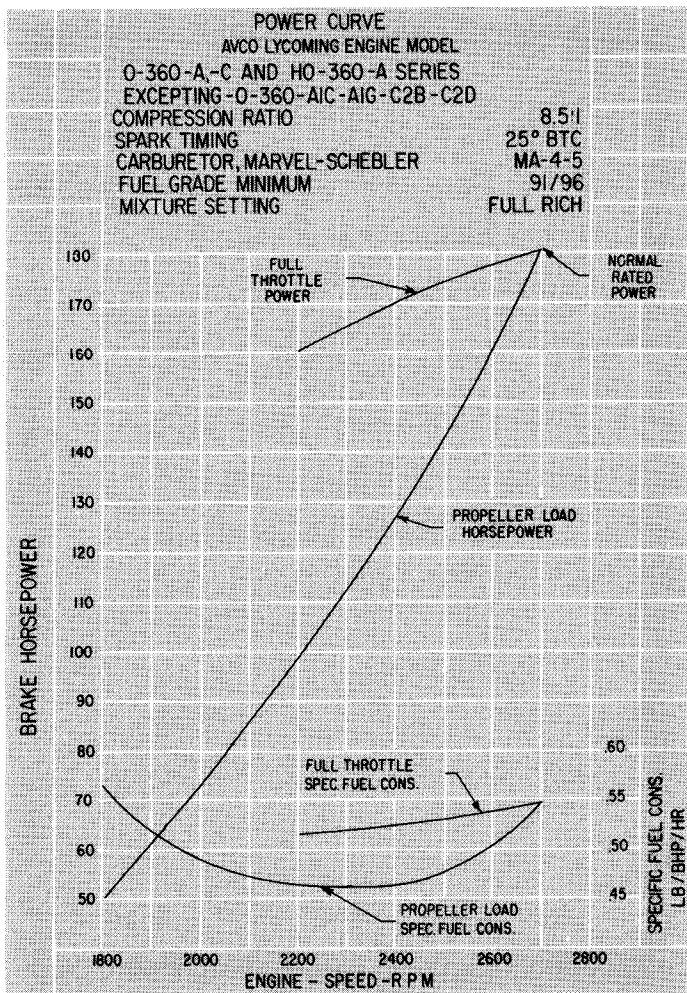

Figure 3-2. Power Curve - O-360-A, -C Series
 Excepting O-360-A1C, -A1G, -C2B, -C2D

CURVE NO. 10818

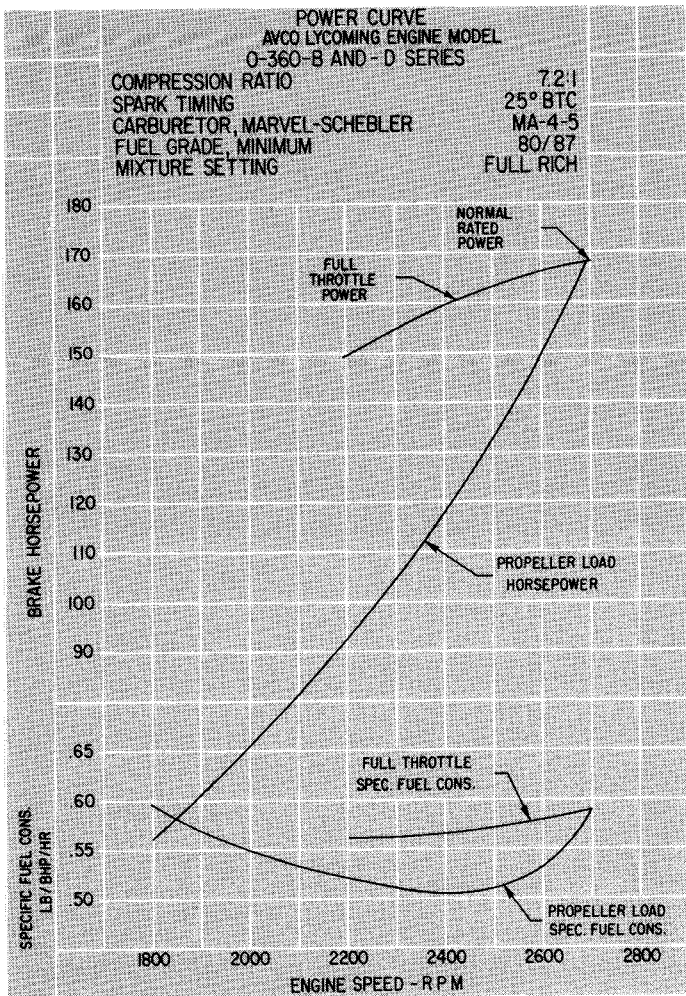

Figure 3-3. Power Curve - O-360-B, -D Series

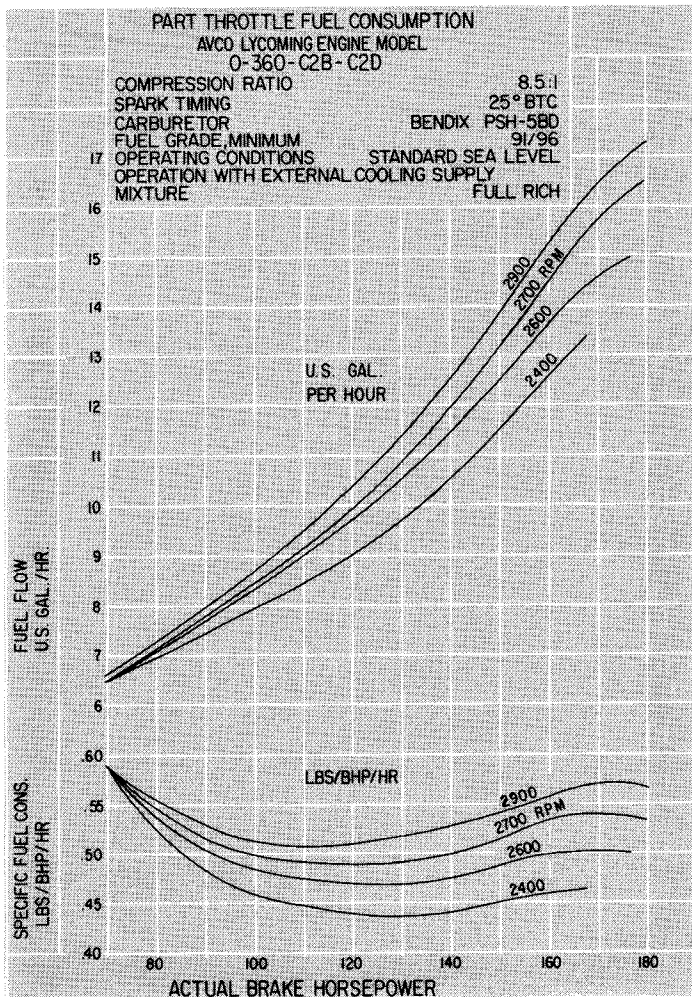

Figure 3-4. Part Throttle Fuel Consumption -
 O-360-C2B, -C2D

CURVE NO. 12880

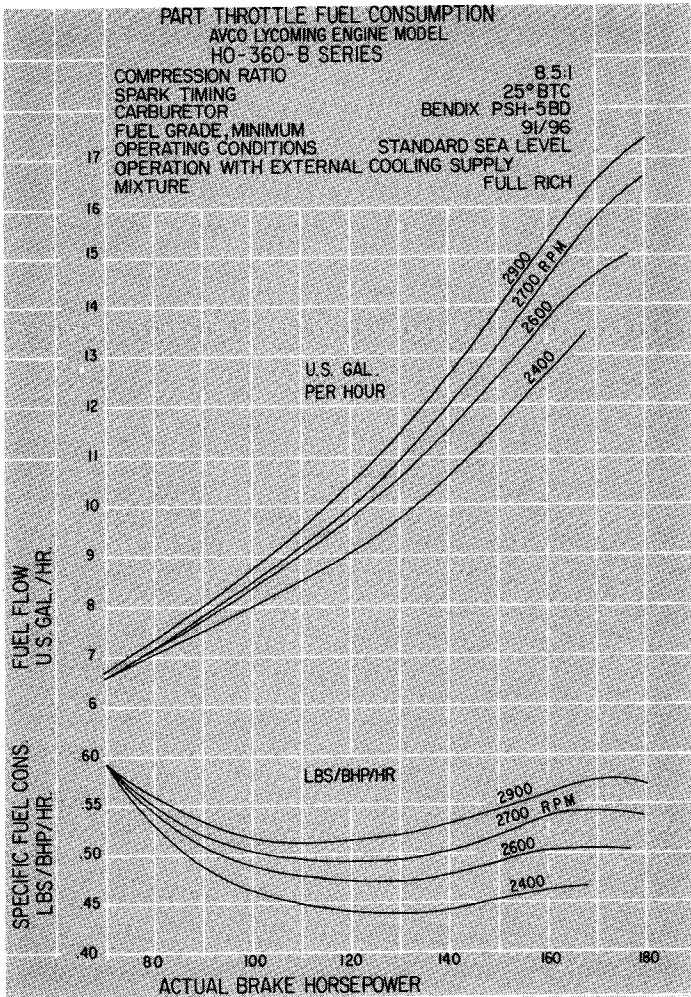

Figure 3-5. Part Throttle Fuel Consumption - HO-360-B Series

SECTION 3

O-360 and ASSOCIATED MODELS

CURVE NO. 12699B

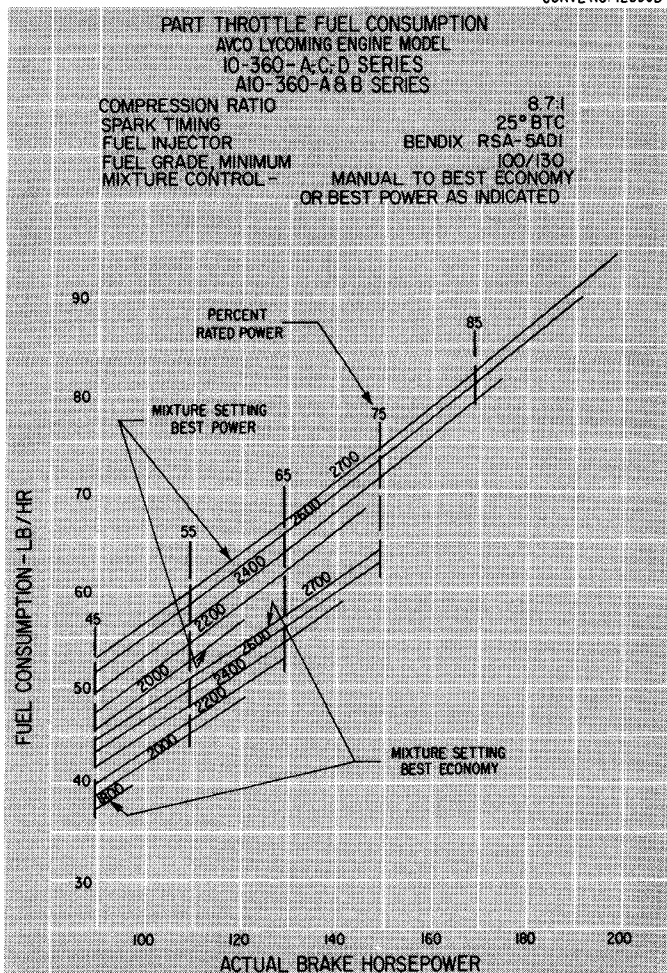
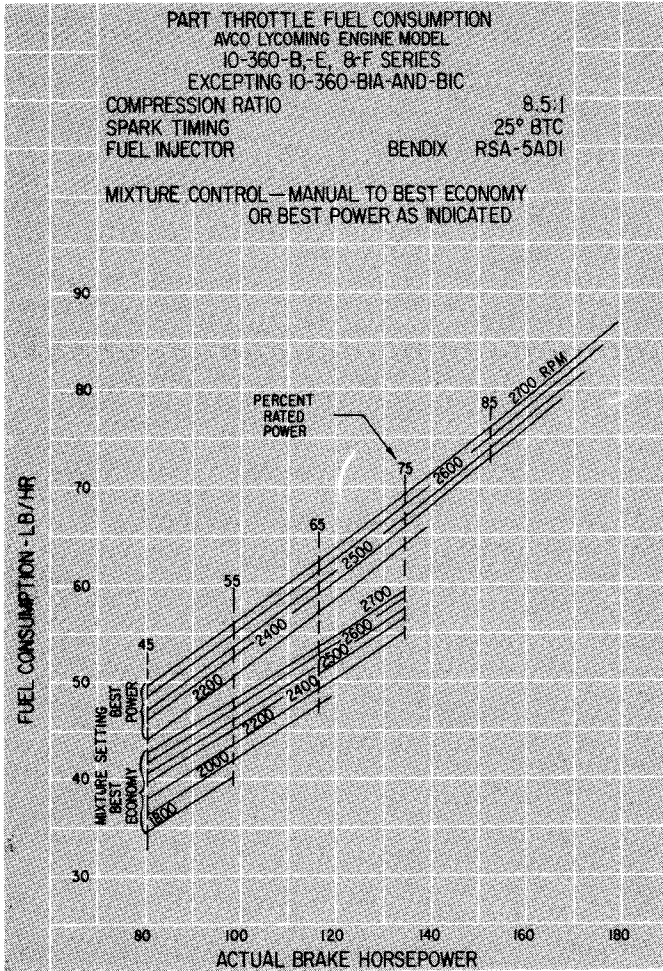

Figure 3-6. Part Throttle Fuel Consumption - IO-360-A, -C, -D, AIO-360 Series

CURVE NO. 12849A



**Figure 3-7. Part Throttle Fuel Consumption -
 IO-360-B, -E, -F Series
 Excepting IO-360-B1A, -B1C**

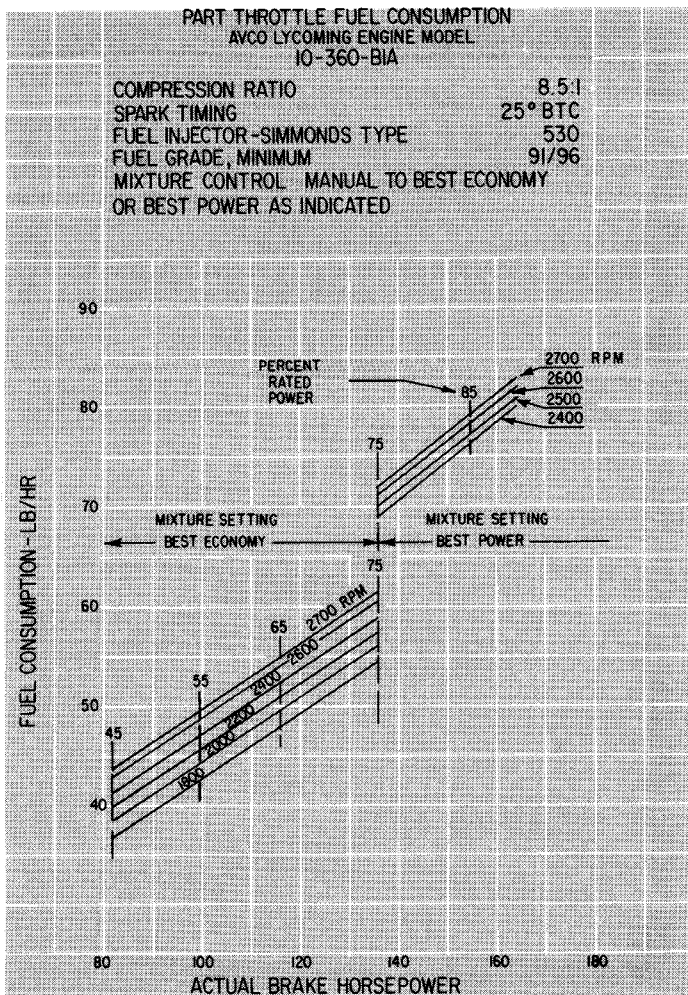

Figure 3-8. Part Throttle Fuel Consumption -
IO-360-B1A

CURVE NO. I2952

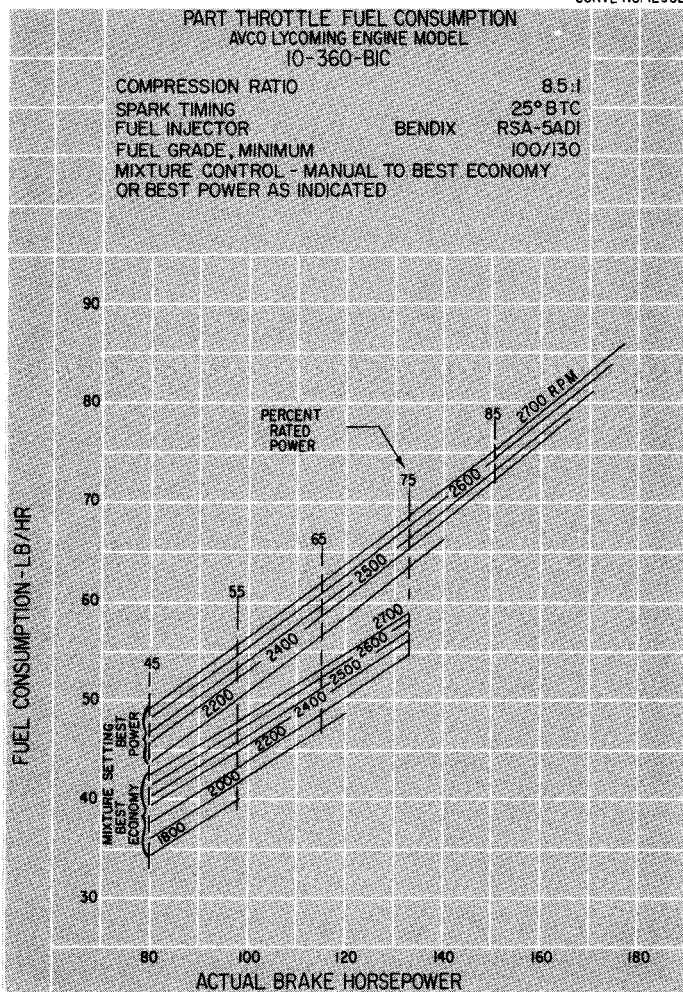

Figure 3-9. Part Throttle Fuel Consumption - IO-360-B1C

SECTION 3

O-360 and ASSOCIATED MODELS

CURVE NO. 13078

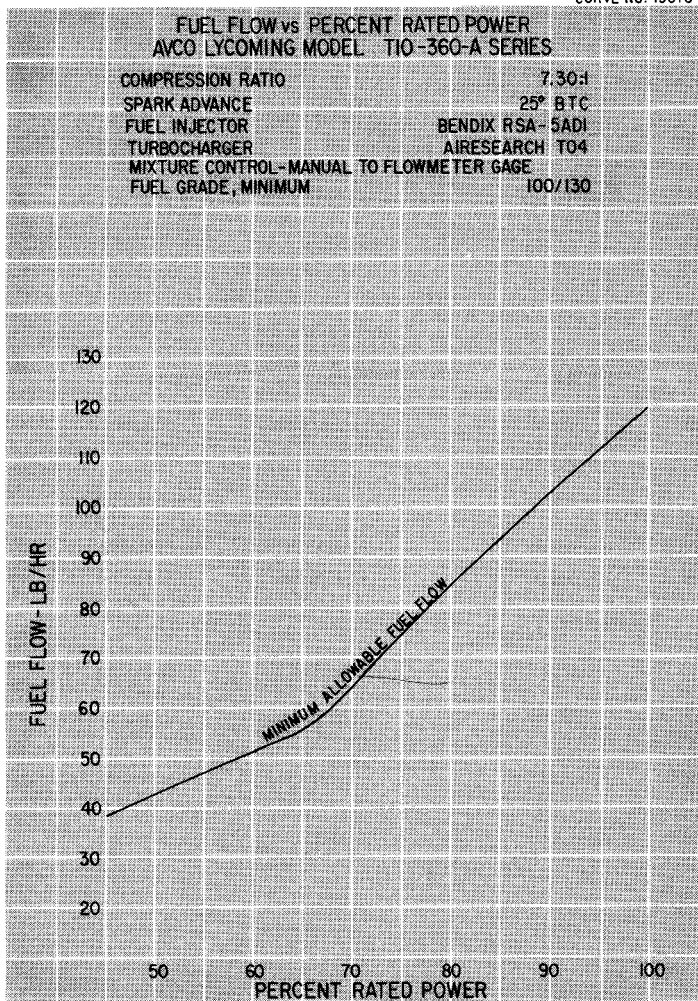

Figure 3-10. Fuel Flow vs Percent Rated Power - TIO-360-A Series

CURVE NO. I3063-A

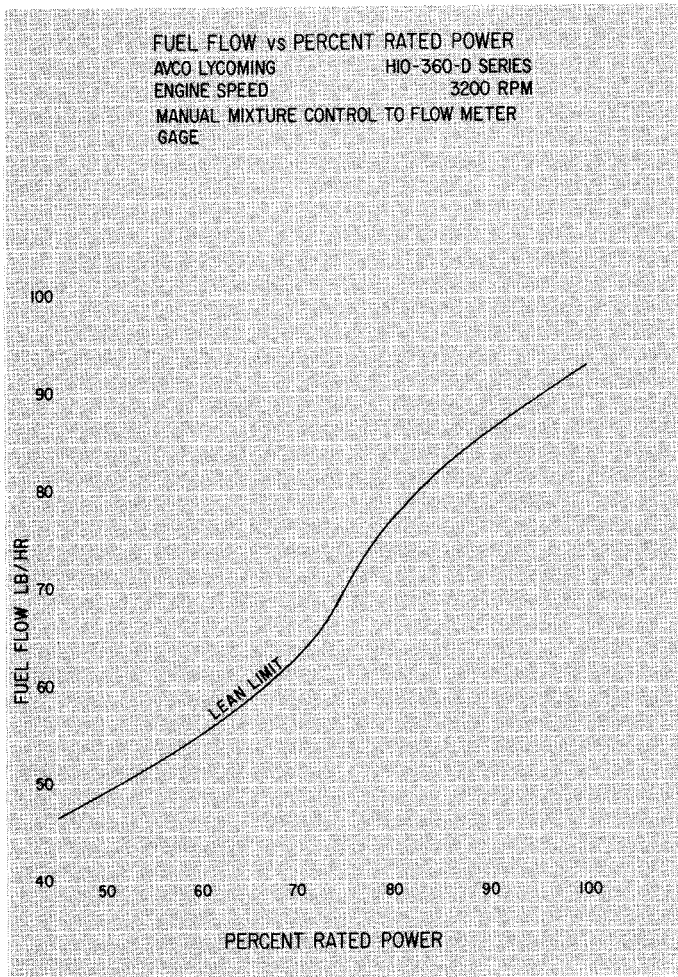

Figure 3-11. Fuel Flow vs Percent Rated Power - HIO-360-D

SHEET 1 OF 2 CURVE NO. 13064-B

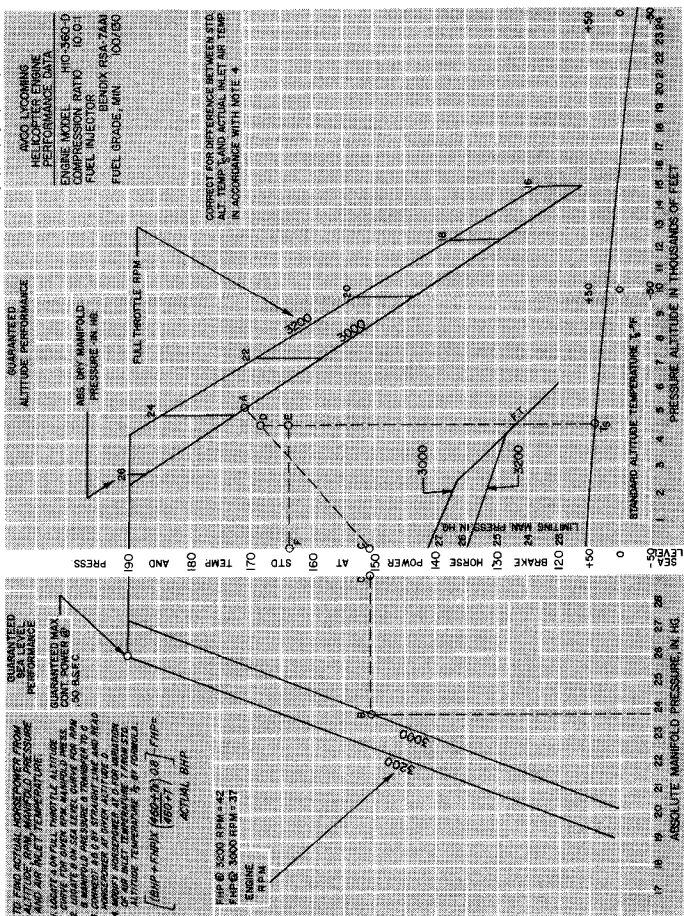

Figure 3-12. Sea Level and Altitude Performance - HIO-360-D - Sheet 1 of 2

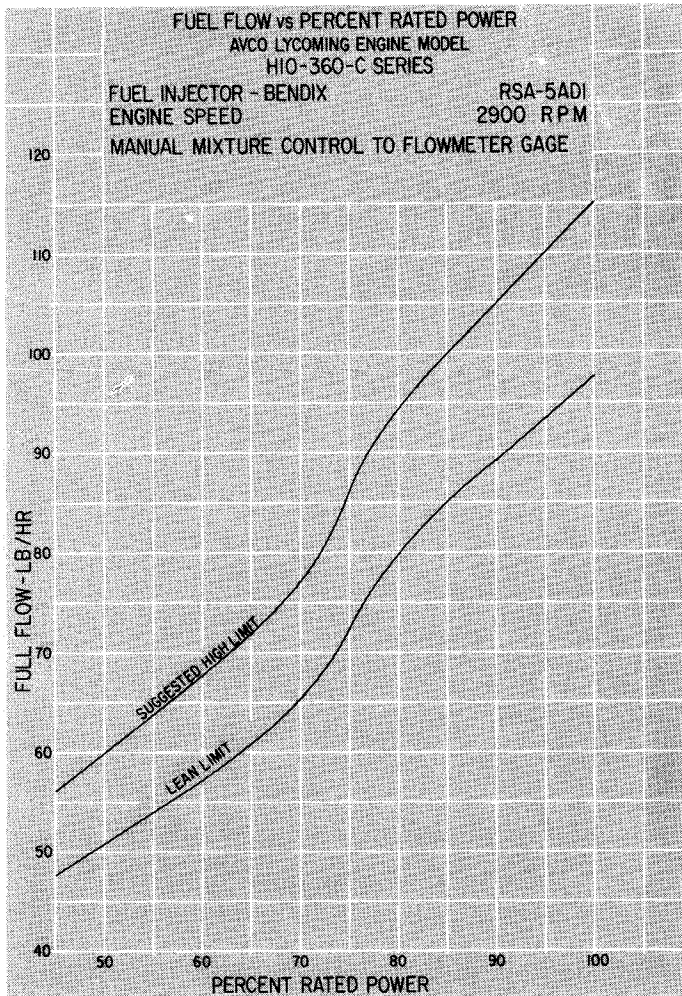

Figure 3-16. Fuel Flow vs Percent Rated Power
H10-360-C Series

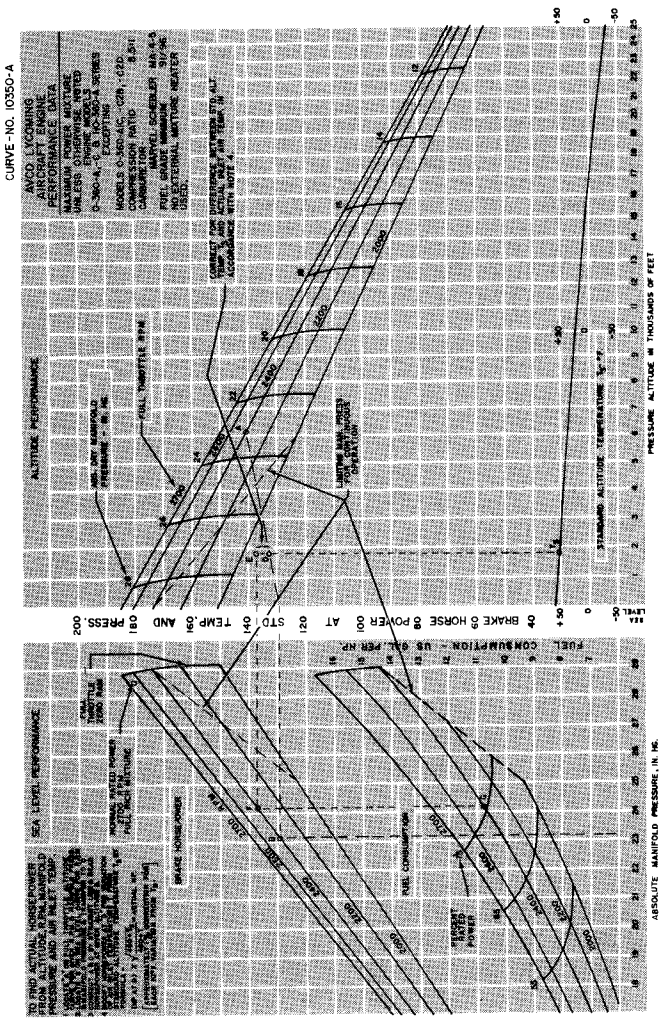

Figure 3-17. Sea Level and Altitude Performance - O-360-A, -C, HO-360-A Series Excepting O-360-A1C, -C2B, -C2D

CURVE No. 12122-B

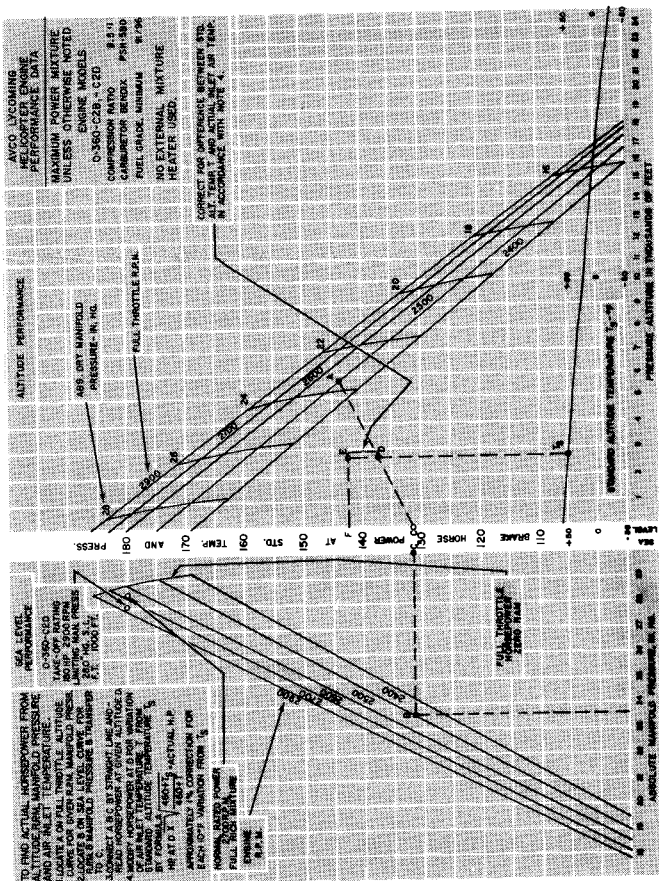

Figure 3-18. Sea Level and Altitude Performance - O-360-C2B, -C2D

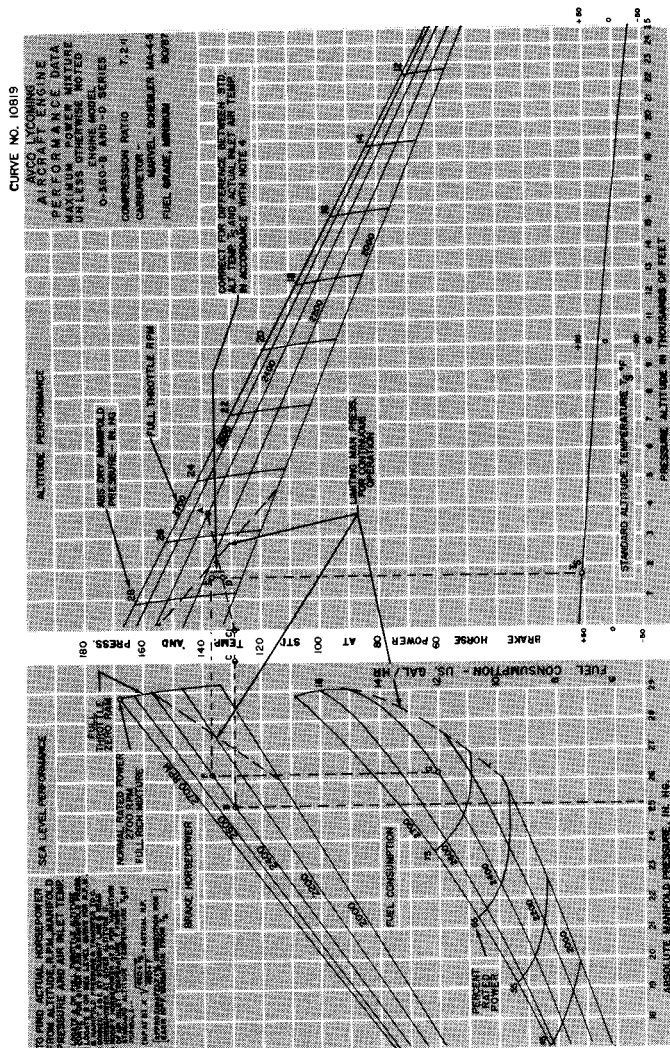

Figure 3-19. Sea Level and Altitude Performance - O-360-B, -D Series

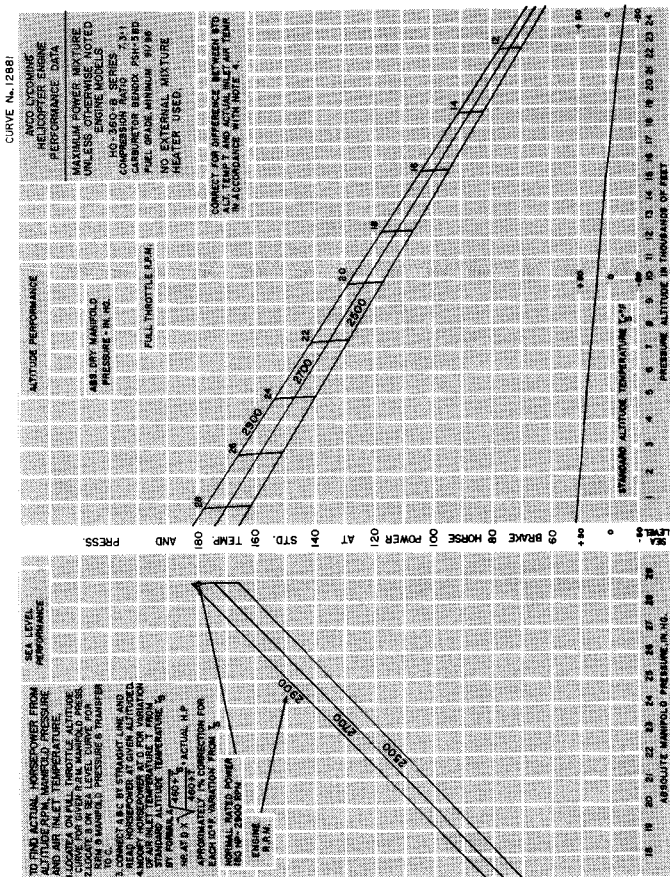

Figure 3-20. Sea Level and Altitude Performance - HO-360-B Series

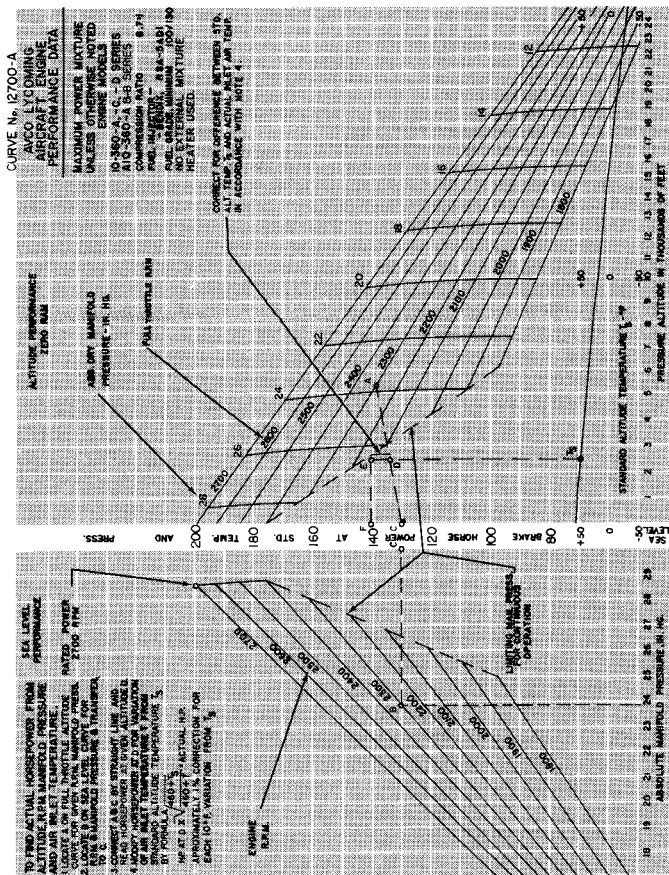

Figure 3-21. Sea Level and Altitude Performance - IO-360-A, -C, -D, AIO-360 Series

CURVE No. 12850

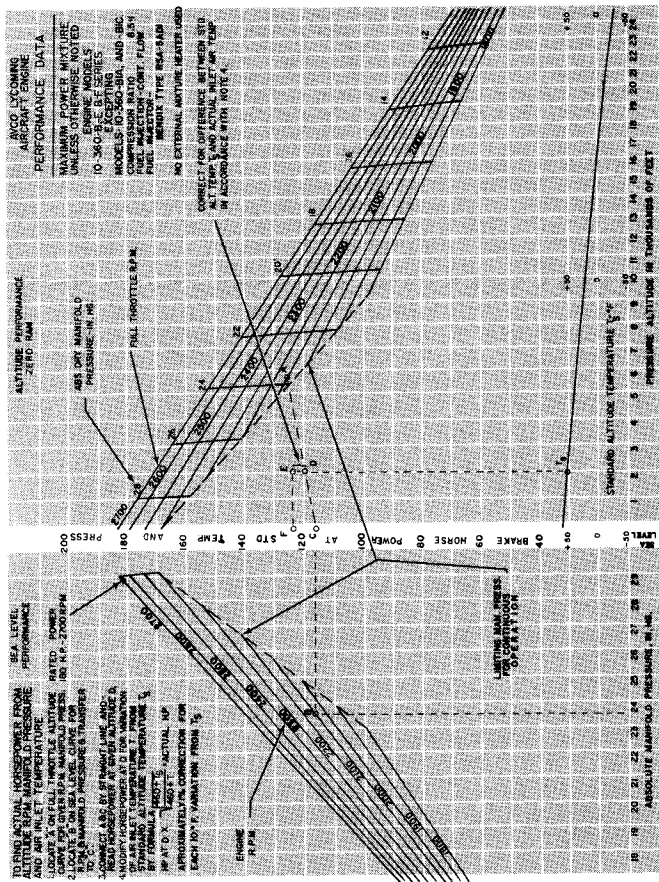

Figure 3-22. Sea Level and Altitude Performance - IO-360-B, -E, -F Series Excepting IO-360-B1A, -B1C

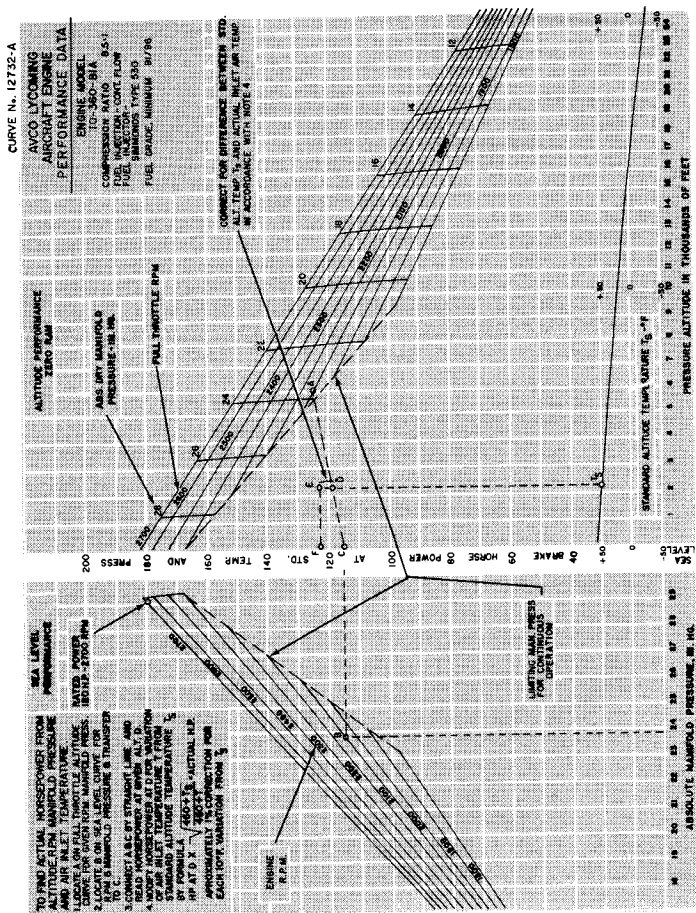

Figure 3-23. Sea Level and Altitude Performance IO-360-B1A

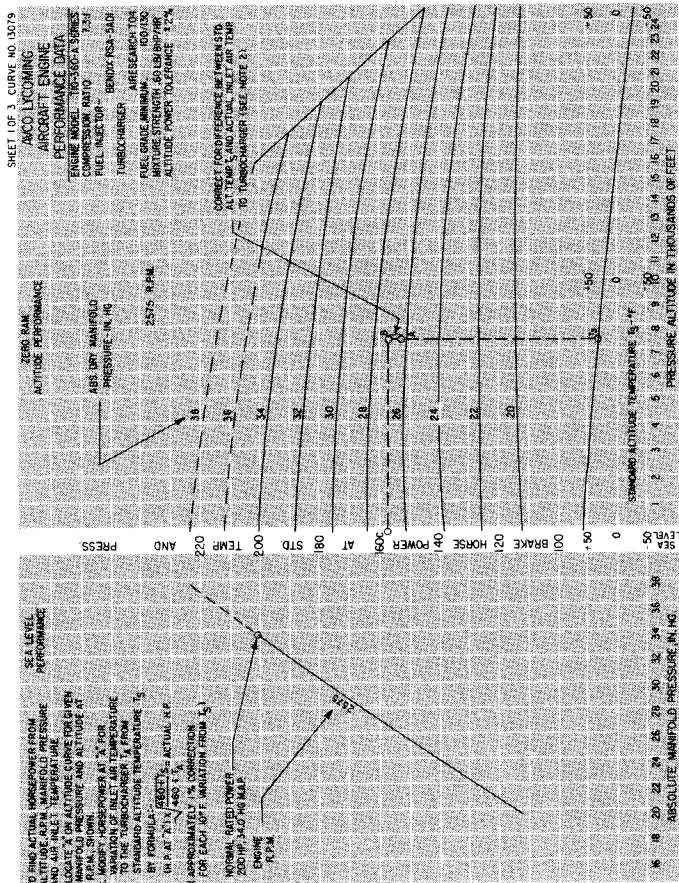

Figure 3-28. Sea Level and Altitude Performance - TIO-360-A Series - Sheet 1 of 3

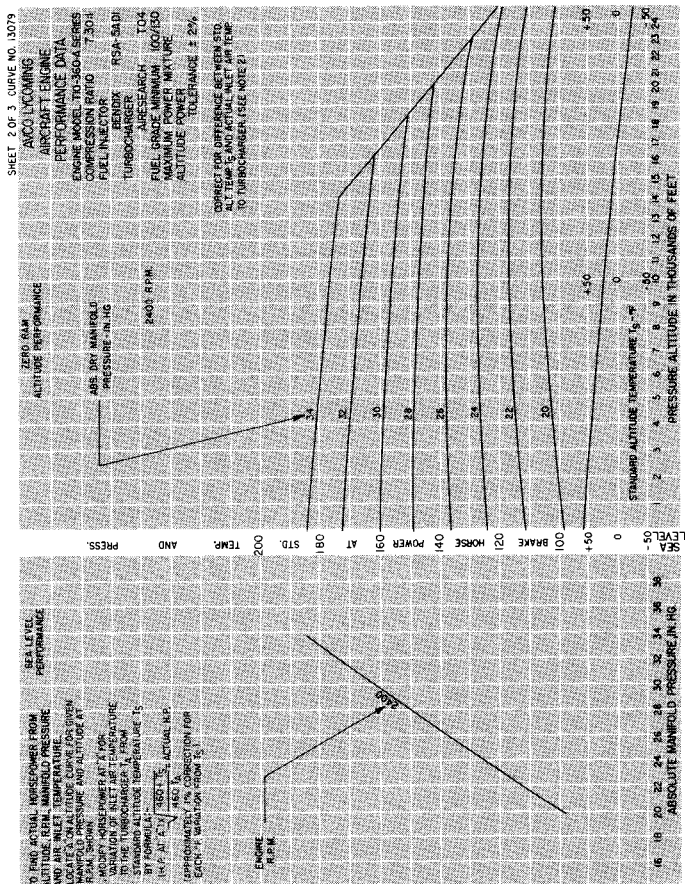

Figure 3-29. Sea Level and Altitude Performance - TIO-360-A Series - Sheet 2 of 3

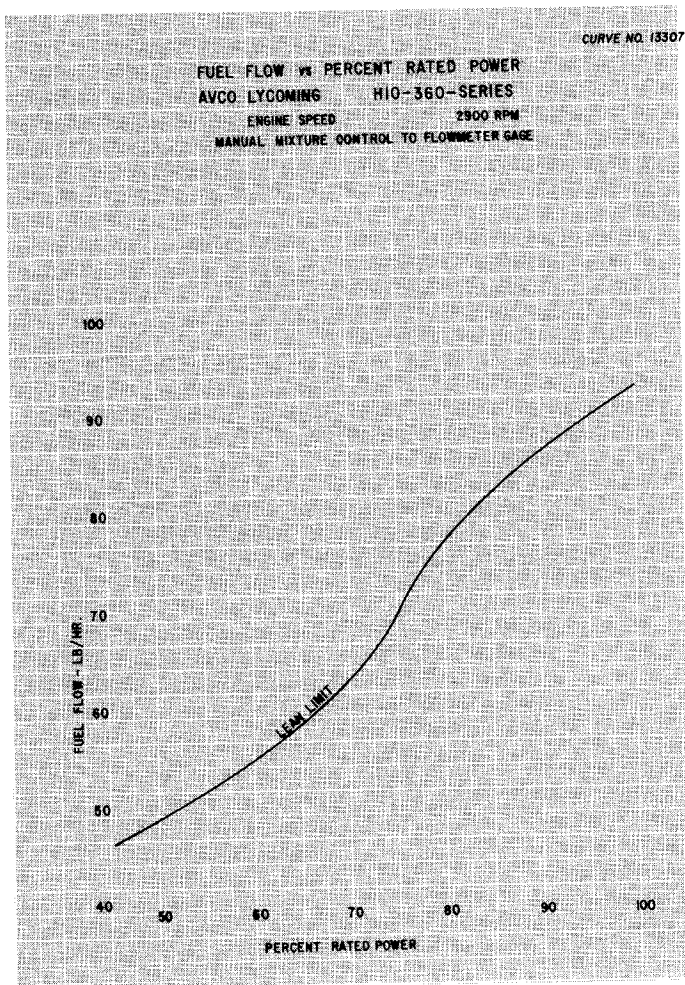

Figure 3-31. Fuel Flow vs. Percent Rated Power - HIO-360-E Series

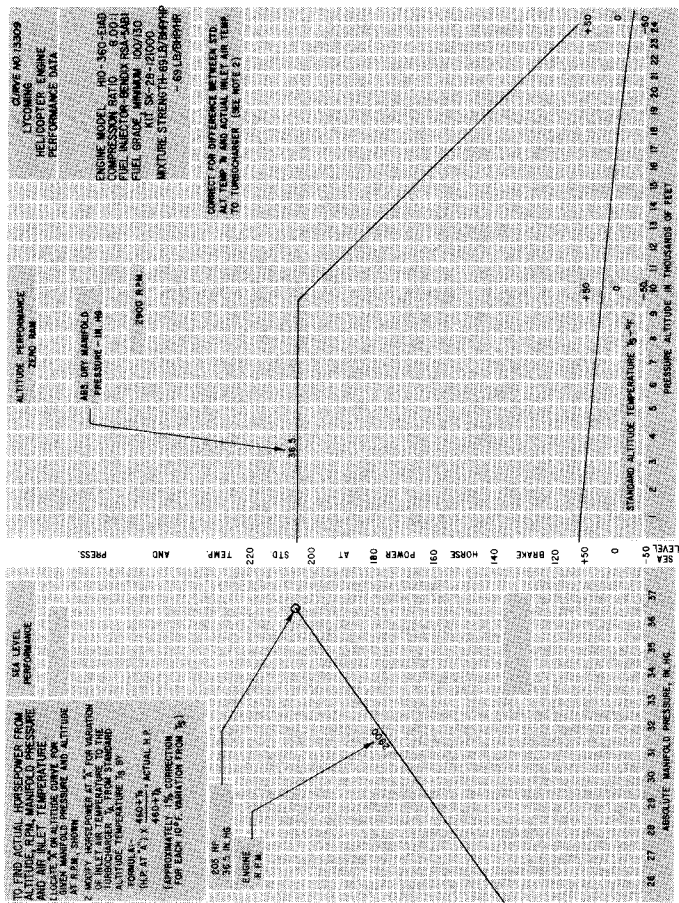

Figure 3-33. Sea Level and Altitude Performance with Turbocharger
 Kit SK-28-121000 - HIO-360-E Series

PERIODIC INSPECTIONS

	Page
Pre-Starting Inspection4-1
Daily Pre-Flight	
Engine4-2
Turbocharger4-2
25 Hour Inspection	
Engine4-2
50 Hour Inspection	
Engine4-3
Turbocharger4-4
100 Hour Inspection	
Engine4-4
Turbocharger4-5
400 Hour Inspection	
Engine4-5
Non-Scheduled Inspections4-6

SECTION 4**PERIODIC INSPECTIONS****NOTE**

Perhaps no other factor is quite so important to safety and durability of the aircraft and its components as faithful and diligent attention to regular checks for minor troubles and prompt repair when they are found.

The operator should bear in mind that the items listed in the following pages do not constitute a complete aircraft inspection, but are meant for the engine only. Consult the airframe manufacturer's handbook for additional instructions.

Pre-Starting Inspection - The daily pre-flight inspection is a check of the aircraft prior to the first flight of the day. This inspection is to determine the general condition of the aircraft and engine.

The importance of proper pre-flight inspection cannot be over emphasized. Statistics prove several hundred accidents occur yearly directly responsible to poor pre-flight.

Among the major causes of poor pre-flight inspection are lack of concentration, reluctance to acknowledge the need for a check list, carelessness bred by familiarity and haste.

SECTION 4

O-360 and ASSOCIATED MODELS

*1. DAILY PRE-FLIGHT.**a. Engine*

- (1) Be sure all switches are in the "Off" position.
- (2) Be sure magneto ground wires are connected.
- (3) Check oil level.
- (4) See that fuel tanks are full.
- (5) Check fuel and oil line connections, note minor indications for repair at 50 hour inspection. Repair any leaks before aircraft is flown.
- (6) Open the fuel drain to remove any accumulation of water and sediment.
- (7) Make sure all shields and cowling are in place and secure. If any are missing or damaged, repair or replacement should be made before the aircraft is flown.
- (8) Check controls for general condition, travel and freedom of operation.
- (9) Induction system air filter should be inspected and serviced in accordance with the airframe manufacturer's recommendations.

b. Turbocharger

- (1) Inspect mounting and connections of turbocharger for security, lubricant or air leakage.
- (2) Check engine crankcase breather for restrictions to breather.

2. 25 HOUR INSPECTION (ENGINE). After the first twenty-five hours operating time; new, remanufactured or newly overhauled engines should undergo a 50 hour inspection including draining and renewing lubricating oil.

3. 50 HOUR INSPECTION (ENGINE). In addition to the items listed for daily pre-flight inspection, the following maintenance checks should be made after every 50 hours of operation.

a. Ignition System -

(1) If fouling of spark plugs has been apparent, rotate bottom plugs to upper position.

(2) Examine spark plug leads of cable and ceramics for corrosion and deposits. This condition is evidence of either leaking spark plugs, improper cleaning of the spark plug walls or connector ends. Where this condition is found, clean the cable ends, spark plug walls and ceramics with a dry, clean cloth or a clean cloth moistened with methyl-ethyl ketone. All parts should be clean and dry before reassembly.

(3) Check ignition harness for security of mounting clamps and be sure connections are tight at spark plug and magneto terminals.

b. Fuel and Induction System - Check the primer lines for leaks and security of the clamps. Remove and clean the fuel inlet strainers. Check the mixture control and throttle linkage for travel, freedom of movement, security of the clamps and lubricate if necessary. Check the air intake ducts for leaks, security, filter damage; evidence of dust or other solid material in the ducts is indicative of inadequate filter care or damaged filter. Check vent lines for evidence of fuel or oil seepage; if present, fuel pump may require replacement.

c. Lubrication System -

(1) Replace external full flow oil filter element. (Check used element for metal particles). Drain and renew lubricating oil on installations not employing full flow filter with replaceable element.

NOTE

Intervals between oil changes can be increased as much as 100% on engines equipped with full flow oil filters - provided the element is replaced each 50 hours of operation.

(2) *(Engines Not Equipped with External Filter) -* Remove oil suction screen and clean thoroughly. Note carefully for presence of metal particles that are indicative of internal engine damage.

SECTION 4**O-360 and ASSOCIATED MODELS**

(3) Check oil lines for leaks, particularly at connections for security of anchorage and for wear due to rubbing or vibration, for dents and cracks.

d. Exhaust System - Check attaching flanges at exhaust ports on cylinder for evidence of leakage. If they are loose, they must be removed and machined flat before they are reassembled and tightened. Examine exhaust manifolds for general condition.

e. Cooling System - Check cowling and baffles for damage and secure anchorage. Any damaged or missing part of the cooling system must be repaired or replaced before the aircraft resumes operation.

f. Cylinders - Check rocker box covers for evidence of oil leaks. If found, replace gasket and tighten screws to specified torque (50 inch lbs.).

Check cylinders for evidence of excessive heat which is indicated by burned paint on the cylinder. This condition is indicative of internal damage to the cylinder and, if found, its cause must be determined and corrected before the aircraft resumes operation.

Heavy discoloration and appearance of seepage at cylinder head and barrel attachment area is usually due to emission of thread lubricant used during assembly of the barrel at the factory, or by slight gas leakage which stops after the cylinder has been in service for awhile. This condition is neither harmful nor detrimental to engine performance and operation. If it can be proven that leakage exceeds these conditions, the cylinder should be replaced.

g. Turbocharger - All fluid power lines and mounting brackets incorporated in turbocharger system should be checked for leaks, tightness and any damage that may cause a restriction.

Check for accumulation of dirt or other interference with the linkage between the bypass valve and the actuator which may impair operation of turbocharger. Clean or correct cause of interference.

The vent line from the actuator should be checked for oil leakage. Any constant oil leakage is cause for replacement of piston seal.

Check alternate air valve to be sure it swings free and seals tightly.

b. Carburetor - Check throttle body attaching screws for tightness. The correct torque for these screws is 40 to 50 inch pounds.

4. 100 HOUR INSPECTION. In addition to the items listed for daily pre-flight and 50 hour inspection, the following maintenance checks should be made after every one hundred hours of operation.

a. Electrical System -

(1) Check all wiring connected to the engine or accessories. Any shielded cables that are damaged should be replaced. Replace clamps or loose wires and check terminals for security and cleanliness.

(2) Remove spark plugs; test, clean and regap. Replace if necessary.

b. Lubrication System - Drain and renew lubricating oil.

c. Magnetos - Check breaker points for pitting and minimum gap. Check for excessive oil in the breaker compartment, if found, wipe dry with a clean lintless cloth. The felt located at the breaker points should be lubricated in accordance with the magneto manufacturer's instructions. Check magneto to engine timing. Timing procedure is described in Section 5, 1, b of this manual.

d. Engine Accessories - Engine mounted accessories such as pumps, temperature and pressure sensing units should be checked for secure mounting, tight connections.

e. Cylinders - Check cylinders visually for cracked or broken fins.

f. Engine Mounts - Check engine mounting bolts and bushings for security and excessive wear. Replace any bushings that are excessively worn.

g. Fuel Injection Nozzles and Fuel Lines - Check fuel injector nozzles for looseness, tighten to 60 inch pounds torque. Check fuel line for dye stains at connection indicating leakage and security of line. Repair or replacement must be accomplished before the aircraft resumes operation.

SECTION 4

O-360 and ASSOCIATED MODELS

b. Turbocharger - Inspect all air ducting and connections in turbocharger system for leaks. Make inspection both with engine shut down and with engine running. Check at manifold connections to turbine inlet and at engine exhaust manifold gasket, for possible exhaust gas leakage.

CAUTION

Do not operate the turbocharger if leaks exist in the ducting, or if air cleaner is not filtering efficiently. Dust leaking into air ducting can damage turbocharger and engine.

Check for dirt or dust build-up within the turbocharger. Check for uneven deposits on the impeller. Consult AiResearch Industrial Div. Manual TP-21 for method to removal all such foreign matter.

5. 400 HOUR INSPECTION. In addition to the items listed for daily pre-flight, 50 hour and 100 hour inspections, the following maintenance check should be made after every 400 hours of operation.

Valve Inspection - Remove rocker box covers and check for freedom of valve rockers when valves are closed. Look for evidence of abnormal wear or broken parts in the area of the valve tips, valve keeper, springs and spring seats. If any indications are found, the cylinder and all of its components should be removed (including the piston and connecting rod assembly) and inspected for further damage. Replace any parts that do not conform with limits shown in the latest revision of Special Service Publication No. SSP2070.

6. NON-SCHEDULED INSPECTIONS. Occasionally, service bulletins or service instructions are issued by Avco Lycoming Division that require inspection procedures that are not listed in this manual. Such publications, usually are limited to specified engine models and become obsolete after corrective modification has been accomplished. All such publications are available from Avco Lycoming distributors, or from the factory by subscription. Consult the latest edition of Service Letter No. L114 for subscription information. Maintenance facilities should have an up-to-date file of these publications available at all times.

MAINTENANCE PROCEDURES

Page

Ignition and Electrical System

Ignition Harness and Wire Replacement5-1
 Timing Magnetos to Engine5-1
 Generator or Alternator Output5-5

Fuel System

Repair of Fuel Leaks5-5
 Carburetor or Fuel Injector Inlet
 Screen Assembly5-5
 Fuel Grades and Limitations5-5
 Air Intake Ducts and Filters5-5
 Idle Speed and Mixture Adjustment5-5

Lubrication System

Oil Grades and Limitations5-6
 Oil Suction and Oil Pressure Screens5-6
 Oil Pressure Relief Valve5-6

Cylinder Assembly5-7

Turbocharger Control System5-13

Generator or Alternator Drive Belt Tension5-13

SECTION 5**MAINTENANCE PROCEDURES**

The procedures described in this section are provided to guide and instruct personnel in performing such maintenance operations that may be required in conjunction with the periodic inspections listed in the preceding section. No attempt is made to include repair and replacement operations that will be found in the applicable Avco Lycoming Overhaul Manual.

1. IGNITION AND ELECTRICAL SYSTEM.

a. Ignition Harness and Wire Replacement - In the event that an ignition harness or an individual lead is to be replaced, consult the wiring diagram to be sure harness is correctly installed. Mark location of clamps and clips to be certain the replacement is clamped at correct locations.

b. Timing Magnetos to Engine -

(1) Remove a spark plug from No. 1 cylinder and place a thumb over the spark plug hole. Rotate the crankshaft in direction of normal rotation until the compression stroke is reached, this is indicated by a positive pressure inside the cylinder tending to push the thumb off the spark plug hole. Continue rotating the crankshaft until the advance timing mark on the front face of the starter ring gear is in alignment with the small hole located at the two o'clock position on the front face of the starter housing. (Ring gear may be marked at 20° and 25°. Consult specifications for correct timing mark for your installation.) At this point, the engine is ready for assembly of the magnetos.

(2) *Single magneto* - Remove the inspection plugs from both magnetos and turn the drive shaft in direction of normal rotation until (-20 and -200 series) the first painted chamfered tooth on the distributor gear is aligned in the center of the inspection window (-1200 series) the applicable timing mark on the distributor gear is approximately aligned with the mark on the distributor block. See figure 5-2. Being sure the gear does not move from this position, install gaskets and magnetos on the engine. Note that an adapter is used with impulse coupling magneto. Secure with (clamps on -1200 series) washers and nuts; tighten only finger tight.

SECTION 5

O-360 and ASSOCIATED MODELS

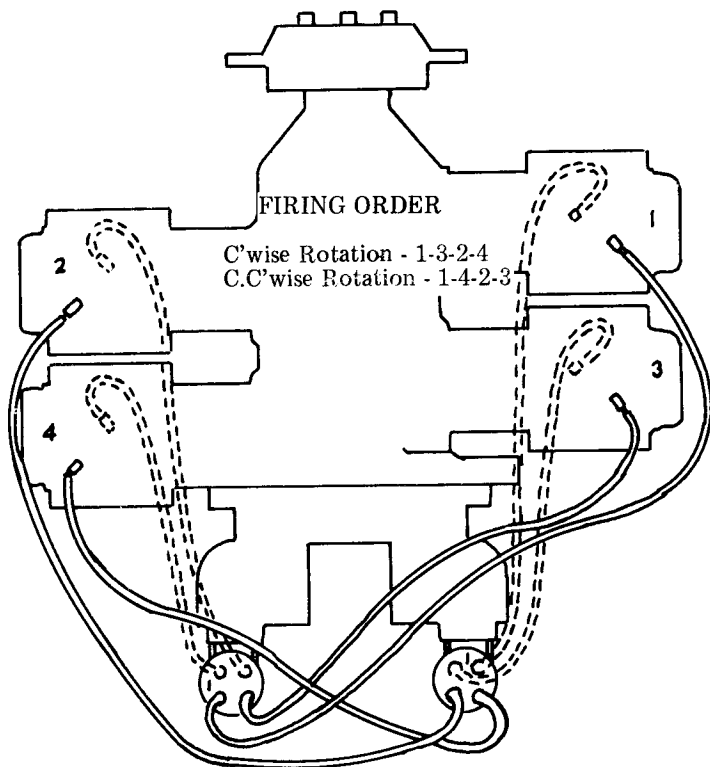

Figure 5-1. Ignition Wiring Diagram

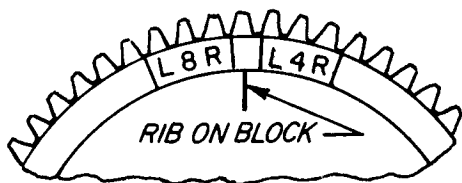

Figure 5-2. Timing Marks - 4 cyl. 1200 Series

(3) Using a battery powered timing light, attach the positive lead to a suitable terminal connected to the switch terminal of the magneto and the negative lead to any unpainted portion of the engine. Rotate the magneto in its mounting flange to a point where the light comes on, then slowly turn it in the opposite direction until the light goes out. Bring the magneto back slowly until the light just comes on. Repeat this with the second magneto.

(4) Back off the crankshaft a few degrees, the timing lights should go out. Bring the crankshaft slowly back in direction of normal rotation until the timing mark and the hole in the starter housing are in alignment. At this point, both lights should go on simultaneously. Tighten nuts to specified torque.

(5) *Dual Magnetos* - Remove the timing window plug from the most convenient side of the housing and the plug from the rotor viewing location in the center of the housing.

(6) Turn the rotating magnet drive shaft in direction of normal rotation until the painted tooth of the distributor gear is centered in the timing hole. Observe that at this time the built in pointer just ahead of the rotor viewing window aligns with either the L or R (depending on rotation).

(7) Hold the magneto in this position and install gasket and magnetos. Secure with clamps, washers and nuts tightened only finger tight.

(8) Using a battery powered timing light, attach one positive lead to left switch terminal, one positive lead to right switch terminal and the ground lead to the magneto housing.

(9) Turn the entire magneto in direction of rotation until the timing light comes on, then slowly turn it in the opposite direction until the light goes out. Bring the magneto back slowly until the light just comes on.

(10) Back off the crankshaft a few degrees, the timing lights should go out. Bring the crankshaft slowly back in direction of normal rotation until the lights just come on. Both lights should go on 2° of No. 1 engine firing position.

SECTION 5**O-360 and ASSOCIATED MODELS****NOTE**

Some timing lights operate in the reverse manner as described. The light comes on when the breaker points open. Check your timing light instructions.

c. Internal Timing - Dual Magneto - Check the magneto internal timing and breaker synchronization in the following manner.

(1) *Main Breakers* - Connect the timing light negative lead to any unpainted surface of the magneto. Connect one positive lead to the left main breaker terminal and the second positive lead to the right main breaker terminal.

(2) Back the engine up a few degrees and again bump forward toward number one cylinder firing position while observing timing lights. Both lights should go out to indicate opening of the main breakers when the timing pointer is indicating within the width of the "L" or "R" mark. If breaker timing is incorrect, loosen breaker screws and correct. Retorque breaker screws to 20 to 25 in. lbs.

(3) *Retard Breaker* - Remove timing light leads from the main breaker terminals. Attach one positive lead to retard breaker terminal, and second positive lead to the tachometer breaker terminal, if used.

(4) Back the engine up a few degrees and again bump forward toward number one cylinder firing position until pointer is aligned with 15° retard timing mark. See figure 5-5. Retard breaker should just open at this position.

(5) If retard timing is not correct, loosen cam securing screw and turn the retard breaker cam as required to make retard breaker open per paragraph c(4). Retorque cam screw to 16 to 20 in. lbs.

(6) Observe that tachometer breaker is opened by the cam lobe. No synchronization of this breaker is required.

(7) Check action of impulse coupling (D-2000 series only). With the ignition switch off observe breaker cam end of rotor while manually cranking engine through a firing sequence. Rotor should alternately stop and then (with an audible snap) be rotated rapidly through a retard firing position.

d. Generator or Alternator Output - The generator or alternator (whichever is applicable) should be checked to determine that the specified voltage and current are being obtained.

2. FUEL SYSTEM.

a. Repair of Fuel Leaks - In the event a line or fitting in the fuel system is replaced, only a fuel soluble lubricant such as clean engine oil or Loctite Hydraulic Sealant may be used on tapered threads. Do not use any other form of thread compound.

b. Carburetor or Fuel Injector (Except Simmonds Injectors) Fuel Inlet Screen Assembly - Remove the assembly and check the screen for distortion or openings in the strainer. Replace for either of these conditions. Clean screen assembly in solvent and dry with compressed air and reinstall. The fuel inlet screen assembly is tightened to 35-40 inch pounds on carburetors and 65-70 inch pounds on fuel injectors. The hex head plug on pressure carburetors is tightened to 160-175 inch pounds.

c. Fuel Grades and Limitations - The recommended aviation grade fuel for the subject engines is listed in Section 3, item 8.

In the event that the specified fuel is not available at some locations, it is permissible to use higher octane fuel. Fuel of a lower octane than specified is not to be used. Under no circumstances should automotive fuel be used (regardless of octane rating).

NOTE

It is recommended that personnel be familiar with Service Instruction No. 1070 regarding specified fuel for Avco Lycoming engines.

d. Air Intake Ducts and Filter - Check all air intake ducts for dirt or restrictions. Inspect and service air filters as instructed in the airframe manufacturer's handbook.

e. Idle Speed and Mixture Adjustment -

(1) Start the engine and warm up in the usual manner until oil and cylinder head temperatures are normal.

(2) Check magnetos. If the "mag-drop" is normal, proceed with idle adjustment.

SECTION 5**O-360 and ASSOCIATED MODELS**

(3) Set throttle stop screw so that the engine idles at the airframe manufacturer's recommended idling RPM. If the RPM changes appreciably after making idle mixture adjustment during the succeeding steps, readjust the idle speed to the desired RPM.

(4) When the idling speed has been stabilized, move the cockpit mixture control lever with a smooth, steady pull toward the "Idle-Cut-Off" position and observe the tachometer for any change during the leaning process. Caution must be exercised to return the mixture control to the "Full Rich" position before the RPM can drop to a point where the engine cuts out. An increase of more than 50 RPM while "leaning out" indicates an excessively rich idle mixture. An immediate decrease in RPM (if not preceded by a momentary increase) indicates the idle mixture is too lean.

If the above indicates that the idle adjustment is too rich or too lean, turn the idle mixture adjustment in the direction required for correction, and check this new position by repeating the above procedure. Make additional adjustments as necessary until a check results in a momentary pick-up of approximately 50 RPM. Each time the adjustment is changed, the engine should be run up to 2000 RPM to clear the engine before proceeding with the RPM check. Make final adjustment of the idle speed adjustment to obtain the desired idling RPM with closed throttle. The above method aims at a setting that will obtain maximum RPM with minimum manifold pressure. In case the setting does not remain stable, check the idle linkage; any looseness in this linkage would cause erratic idling. In all cases, allowance should be made for the effect of weather conditions and field altitude upon idling adjustment.

3. LUBRICATION SYSTEM.

a. Oil Grades and Limitations - Service the engine in accordance with the recommended grade oil as specified in Section 3, item 8.

b. Oil Suction and Oil Pressure Screens - At each 100 hour inspection remove, inspect for metal particles, clean and reinstall.

c. Oil Pressure Relief Valve - Subject engines may be equipped with either an adjustable or non-adjustable oil pressure relief valve. A brief description of both types follows.

(1) *Non-Adjustable Oil Pressure Relief Valve* - The valve is not adjustable; however, the pressure can be controlled by the addition of a maximum of three STD-425 washers under the cap to increase pressure or the use of a spacer (Avco Lycoming P/N 73629 or 73630) to decrease pressure. Particles of metal or other foreign matter lodged between the ball and seat will result in a drop in oil pressure. It is advisable, therefore, to disassemble, inspect, and clean the valve if excessive pressure fluctuations are noted. The oil pressure relief valve is not to be mistaken for the oil cooler bypass valve, whose function is to permit pressure oil to bypass the oil cooler in case of an obstruction.

(2) *Oil Pressure Relief Valve (Adjustable)* - The adjustable oil relief valve enables the operator to maintain engine oil pressure within the specified limits. If pressure under normal operating conditions should consistently exceed the maximum or minimum specified limits, adjust the valve as follows:

With the engine warmed up and running at approximately 2000 RPM, observe the reading on the oil pressure gage. If the pressure is above maximum or below minimum specified limits, stop engine and screw the adjusting screw outward to decrease pressure or inward to increase pressure. Depending on installation, the adjusting screw may have only a screw driver slot and is turned with a screw driver; or may have the screw driver slot plus a pinned .375-24 castellated nut and may be turned with either a screw driver or a box wrench.

4. **CYLINDERS.** It is recommended that as a field operation, cylinder maintenance be confined to replacement of the entire assembly. For valve replacement, consult the proper overhaul manual. This should be undertaken only as an emergency measure.

a. Removal of Cylinder Assembly -

(1) Remove exhaust manifold.

(2) Remove rocker box drain tube, intake pipe, baffle and any clips that might interfere with the removal of the cylinder.

(3) Disconnect ignition cables and remove the bottom spark plug.

SECTION 5**O-360 and ASSOCIATED MODELS**

(4) Remove rocker box cover and rotate crankshaft until piston is approximately at top center of the compression stroke. This is indicated by a positive pressure inside of cylinder tending to push thumb off of bottom spark plug hole.

(5) Slide valve rocker shafts from cylinder head and remove the valve rockers. Valve rocker shafts can be removed when the cylinder is removed from the engine. Remove rotator cap from exhaust valve stem.

(6) Remove push rods by grasping ball end and pulling rod out of shroud tube. Detach shroud tube spring and lock plate and pull shroud tubes through holes in cylinder head.

NOTE

The hydraulic tappets, push rods, rocker arms and valves must be assembled in the same location from which they were removed.

(7) Remove cylinder base nuts and hold down plates (where employed) then remove cylinder by pulling directly away from crankcase. Be careful not to allow the piston to drop against the crankcase, as the piston leaves the cylinder.

b. Removal of Piston from Connecting Rod - Remove the piston pin plugs. Insert piston pin puller through piston pin, assemble puller nut; then proceed to remove piston pin. Do not allow connecting rod to rest on the cylinder bore of the crankcase. Support the connecting rod with heavy rubber band, discarded cylinder base oil ring seal, or any other non-marring method.

c. Removal of Hydraulic Tappet Sockets and Plunger Assemblies - It will be necessary to remove and bleed the hydraulic tappet plunger assembly so that dry tappet clearance can be checked when the cylinder assembly is reinstalled. This is accomplished in the following manner:

(1) Remove the hydraulic tappet push rod socket by inserting the forefinger into the concave end of the socket and withdrawing. If the socket cannot be removed in this manner, it may be removed by grasping the edge of the socket with a pair of needle nose pliers. However, care must be exercised to avoid scratching the socket.

(2) To remove the hydraulic tappet plunger assembly, use the special Avco Lycoming service tool. In the event that the tool is not available, the hydraulic tappet plunger assembly may be removed by a hook in the end of a short piece of lockwire, inserting the wire so that the hook engages the spring of the plunger assembly. Draw the plunger assembly out of the tappet body by gently pulling the wire.

CAUTION

Never use a magnet to remove hydraulic plunger assemblies from the crankcase. This can cause the check ball to remain off its seat, rendering the unit inoperative.

d. Assembly of Hydraulic Tappet Plunger Assemblies - To assemble the unit, unseat the ball by inserting a thin clean wire through the oil inlet hole. With the ball off its seat, insert the plunger and twist clockwise so that the spring catches. All oil must be removed before the plunger is inserted.

e. Assembly of Cylinder and Related Parts - Rotate the crankshaft so that the connecting rod of the cylinder being assembled is at the top center of compression stroke. This can be checked by placing two fingers on the intake and exhaust tappet bodies. Rock crankshaft back and forth over top center. If the tappet bodies do not move the crankshaft is on the compression stroke.

(1) Place each plunger assembly in its respective tappet body and assemble the socket on top of plunger assembly.

(2) Assemble piston with rings so that the number stamped on the piston pin boss is toward the front of the engine. The piston pin should be a handpush fit. If difficulty is experienced in inserting the piston pin, it is probably caused by carbon or burrs in the piston pin hole. During assembly, always use a generous quantity of oil, both in the piston hole and on the piston pin.

(3) Assemble one piston pin plug at each end of the piston pin and place a new rubber oil seal ring around the cylinder skirt. Coat piston and rings and the inside of the cylinder generously with oil.

SECTION 5

O-360 and ASSOCIATED MODELS

(4) Using a piston ring compressor, assemble the cylinder over the piston so that the intake port is at the bottom of the engine. Push the cylinder all the way on, catching the ring compressor as it is pushed off.

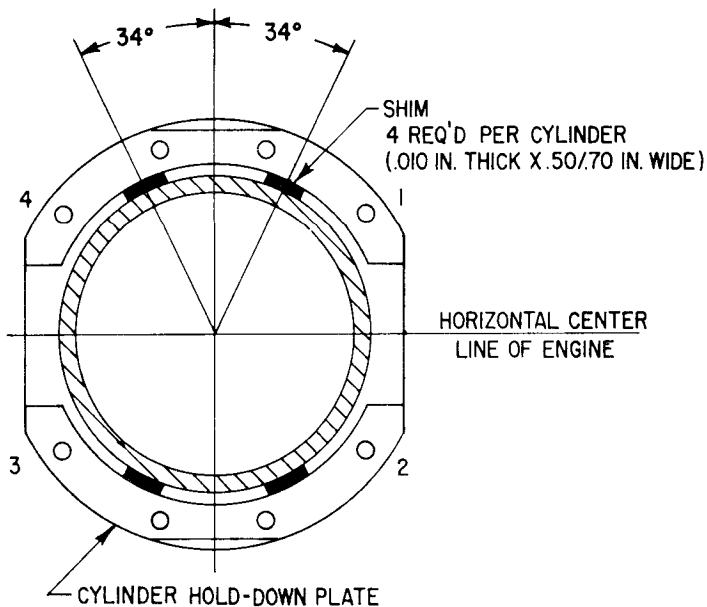

INSTRUCTIONS - ON ENGINES USING CYLINDER HOLD-DOWN PLATES, DURING INITIAL TIGHTENING, USE TWO SHIMS BETWEEN EACH PLATE AND THE BARREL, LOCATED AS SHOWN. REMOVE SHIMS BEFORE FINAL TIGHTENING.

Figure 5-2A. Location of Shims Between Cylinder Barrel and Hold-Down Plates (where applicable) and Sequence of Tightening Cylinder Base Hold-Down Nuts

NOTE

- Before installing cylinder hold-down nuts, lubricate crankcase through stud threads with any one of the following lubricants, or combination of lubricants.
1. 90% SAE 50W engine oil and 10% STP.
 2. Parker Thread Lube.
 3. 60% SAE 30 engine oil and 40% Parker Thread Lube.

(5) Assemble hold-down plates (where applicable) and cylinder base hold-down nuts and tighten as directed in the following steps:

NOTE

At any time a cylinder is replaced, it is necessary to retorque the thru-studs on the cylinder on the opposite side of the engine.

(a) (Engines using hold-down plates) Install shims between cylinder base hold-down plates and cylinder barrel, as directed in figure 5-2A, and tighten 1/2 inch hold-down nuts to 300 inch lbs. (25 foot lbs.) torque, using the sequence shown in figure 5-2A.

(b) Remove shims, and using the same sequence, tighten the 1/2 inch cylinder base nuts, to 600 in. lbs. (50 foot lbs.) torque.

NOTE

Cylinder assemblies not using hold-down plate are tightened in the same manner as above omitting the shims.

(c) Tighten the 3/8 inch hold-down nuts to 300 inch lbs. (25 foot lbs.) torque. Sequence of tightening is optional.

(d) As a final check, hold the torque wrench on each nut for about five seconds. If the nut does not turn, it may be presumed to be tightened to correct torque.

CAUTION

After all cylinder base nuts have been tightened, remove any nicks in the cylinder fins by filing or burring.

(6) Install new shroud tube oil seals on both ends of shroud tube. Install shroud tube and lock in place as required for type of cylinder.

(7) Assemble each push rod in its respective shroud tube, and assemble each rocker in its respective position by placing rocker between bosses and sliding valve rocker shaft in place to retain rocker. Before installing exhaust valve rocker, place rotator cap over end of exhaust valve stem.

(8) Be sure that the piston is at top center of compression stroke and that both valves are closed. Check clearance between the valve stem tip and the valve rocker. In order to check this clearance, place the thumb of one hand on the valve rocker directly over the end of the push rod and push down so as to compress the hydraulic tappet spring. While holding the spring compressed, the valve clearance should be between .028 and .080 inch. If clearance does not come within these limits, remove the push rod and insert a longer or shorter push rod, as required to correct clearance.

NOTE

Inserting a longer push rod will decrease the valve clearance.

(9) Install intercylinder baffles, rocker box covers, intake pipes, rocker box drain tubes and exhaust manifold.

5. TURBOCHARGER CONTROLS.

a. Density Controller. The density controller is adjusted at the factory to maintain a predetermined constant for desired horsepower.

The density controller is set to the curve, see figure 5-3, under the following conditions: Engine stabilized at operating conditions, full throttle with oil pressure at 80 psi 5 psi.

If it is suspected that the manifold pressure is not within limits, it may be checked to the curve.

EXAMPLE

Operating at the stated conditions with a compressor discharge temperature of 120°F., the manifold pressure should be 34.8 in. Hg. .3 in. Hg.

If the manifold pressure is found to be out of limits, the cause might be found either in the density controller, the differential pressure controller or the waste gate. It is recommended that an authorized overhaul facility check these controls.

b. Exhaust Bypass Valve (Waste Gate).

The waste gate butterfly valve is set to a predetermined open and closed clearance. The open and closed positions and the procedures for setting are called out in figure 5-4.

6. GENERATOR OR ALTERNATOR DRIVE BELT TENSION.

Check the tension of a new belt 25 hours after installation. Refer to Service Instruction No. 1129 and Service Letter No. L160 for methods of checking generator or alternator drive belt tension.

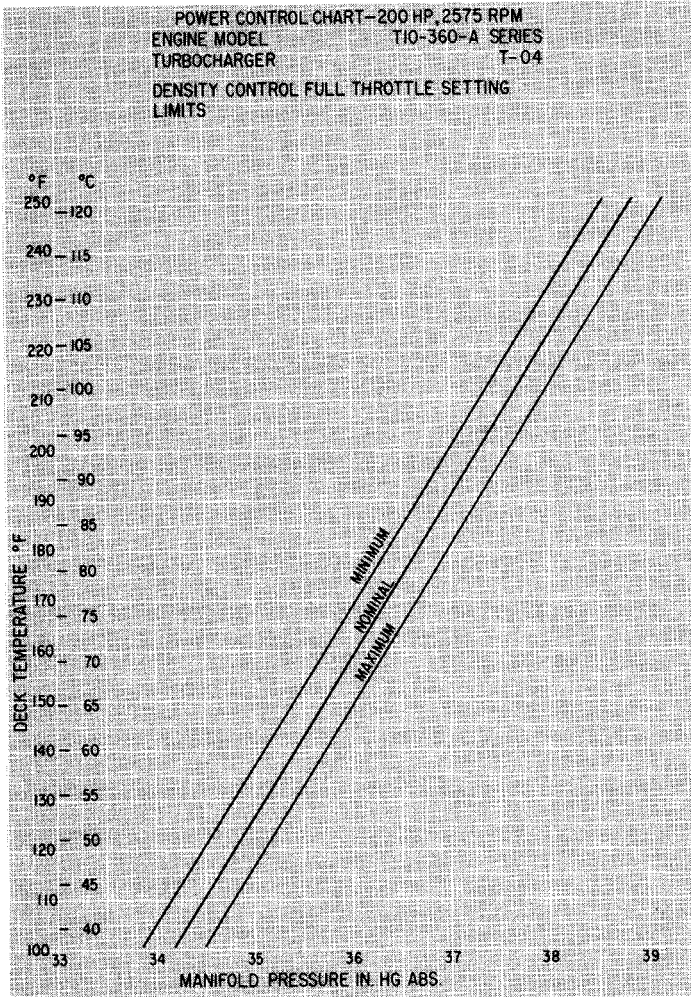

Figure 5-3. Density Control Full Throttle Setting Limits

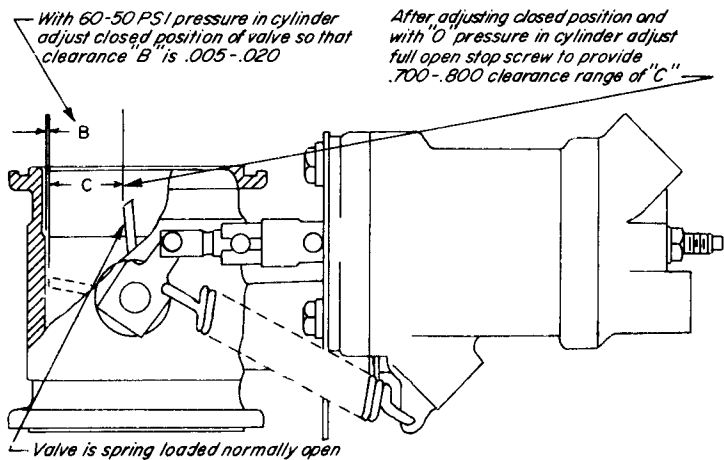

Figure 5-4 Exhaust Bypass Valve Open and Closed Setting

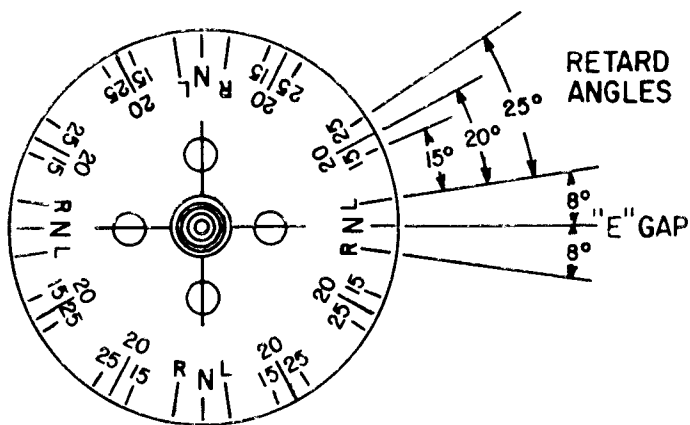

Figure 5-5 Timing Marks on Rotating Magnet

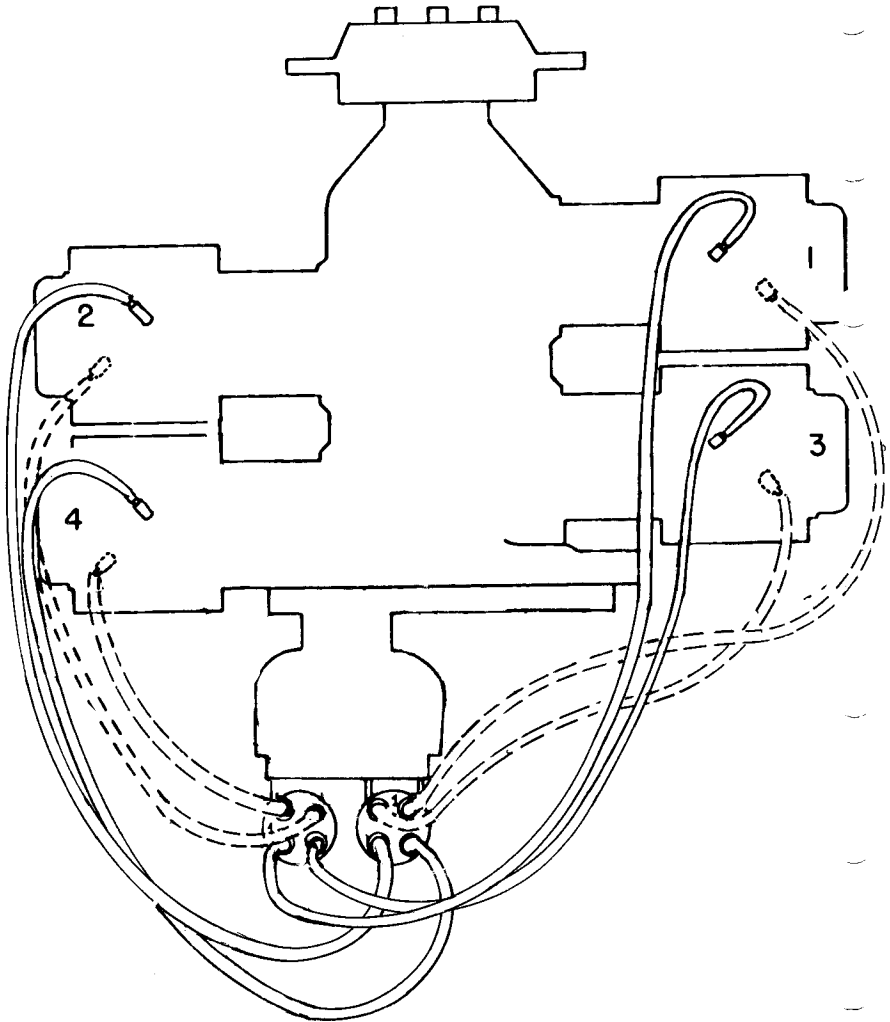

Figure 5-4 Ignition Wiring Diagram, Dual Magneto

TROUBLE-SHOOTING—ENGINE

	Page
Failure of Engine to Start6-1
Failure of Engine to Idle Properly6-2
Low Power and Uneven Running6-2
Failure of Engine to Develop Full Power6-3
Rough Engine6-4
Low Oil Pressure6-4
High Oil Temperature6-4
Excessive Oil Consumption6-5

TROUBLE-SHOOTING—TURBOCHARGER

Excessive Noise or Vibration6-6
Engine Will Not Deliver Rated Power6-6
Critical Altitude Lower Than Specified6-7
Engine Surges or Smokes6-8
High Deck Pressure6-8

SECTION 6

TROUBLE-SHOOTING

Experience has proven that the best method of trouble-shooting is to decide on the various causes of a given trouble and then to eliminate causes one by one, beginning with the most probable. The following charts list some of the more common troubles, which may be encountered in maintaining engines and turbochargers; their probable causes and remedies.

1. TROUBLE-SHOOTING—ENGINE.

TROUBLE	PROBABLE CAUSE	REMEDY
Failure of Engine to Start	Lack of fuel	Check fuel system for leaks. Fill fuel tank. Clean dirty lines, strainers or fuel valves.
	Overpriming	Leave ignition "off" and mixture control in "Idle Cut-Off", open throttle and "unload" engine by cranking for a few seconds. Turn ignition switch on and proceed to start in a normal manner.
	Defective spark plugs	Clean and adjust or replace spark plugs.
	Defective ignition wire	Check with electric tester, and replace any defective wires.
	Defective battery	Replace with charged battery.

SECTION 6
O-360 and ASSOCIATED MODEL

TROUBLE	PROBABLE CAUSE	REMEDY
Failure of Engine to Start (Cont.)	Improper operation of magneto breaker	Clean points. Check internal timing of magnetos.
	Lack of sufficient fuel flow	Disconnect fuel line and check fuel flow.
	Water in fuel injector or carb.	Drain fuel injector or carburetor and fuel lines.
	Internal failure	Check oil screens for metal particles. If found, complete overhaul of the engine may be indicated.
Failure of Engine to Idle Properly	Incorrect idle mixture	Adjust mixture
	Leak in the induction system	Tighten all connections in the induction system. Replace any parts that are defective.
	Incorrect idle adjustment	Adjust throttle stop to obtain correct idle.
	Uneven cylinder compression	Check condition of piston rings and valve seats.
	Faulty ignition system	Check entire ignition system.
	Insufficient fuel pressure	Adjust fuel pressure.
Low Power and Uneven Running	Mixture too rich indicated by sluggish engine operation, red exhaust flame at night. Extreme cases indicated by black smoke from exhaust.	Readjustment of fuel injector or carburetor by authorized personnel is indicated.

TROUBLE	PROBABLE CAUSE	REMEDY
Low Power and Uneven Running (Cont.)	Mixture too lean; indicated by overheating or back-firing	Check fuel lines for dirt or other restrictions. Readjustment of fuel injector or carburetor by authorized personnel is indicated.
	Leaks in induction system	Tighten all connections. Replace defective parts.
	Defective spark plugs	Clean and gap or replace spark plugs.
	Improper fuel	Fill tank with fuel of recommended grade.
	Magneto breaker points not working properly	Clean points. Check internal timing of magnetos.
	Defective ignition wire	Check wire with electric tester. Replace defective wire.
Failure of Engine to Develop Full Power	Defective spark plug terminal connectors.	Replace connectors on spark plug wire.
	Leak in the induction system	Tighten all connections and replace defective parts.
	Throttle lever out of adjustment	Adjust throttle lever.
	Improper fuel flow	Check strainer, gage and flow at the fuel inlet.
	Restriction in air scoop	Examine air scoop and remove restrictions.

SECTION 6 O-360 and ASSOCIATED MODELS

TROUBLE	PROBABLE CAUSE	REMEDY
Failure of Engine to Develop Full Power (Cont.)	Improper fuel	Drain and refill tank with recommended fuel.
	Faulty ignition	Tighten all connections. Check system with tester. Check ignition timing.
Rough Engine	Cracked engine mount	Replace or repair mount.
	Defective mounting bushings	Install new mounting bushings
	Uneven compression	Check compression.
Low Oil Pressure	Insufficient oil	Fill to proper level with recommended oil.
	Air lock or dirt in relief valve	Remove and clean oil pressure relief valve.
	Leak in suction line or pressure line	Check gasket between accessory housing and crankcase.
	High oil temperature	See "High Oil Temperature" in "Trouble" column.
	Defective pressure gage	Replace
	Stoppage in oil pump intake passage	Check line for obstruction. Clean suction strainer.
High Oil Temperature	Insufficient air cooling	Check air inlet and outlet for deformation or obstruction.

O-360 and ASSOCIATED MODELS
SECTION 6

TROUBLE	PROBABLE CAUSE	REMEDY
High Oil Temperature (Cont.)	Insufficient oil supply	Fill to proper level with specified oil.
	Low grade of oil	Replace with oil conforming to specifications.
	Clogged oil lines or strainers	Remove and clean oil strainers.
	Excessive blow-by	Usually caused by worn or stuck rings.
	Failing or failed bearing	Examine sump for metal particles. If found, overhaul of engine is indicated.
Excessive Oil Consumption	Defective temperature gage	Replace gage.
	Low grade of oil	Fill tank with oil conforming to specification.
	Failing or failed bearings	Check sump for metal particles.
	Worn piston rings	Install new rings.
	Incorrect installation of piston rings	Install new rings.
	Failure of rings to seat (new nitrided cyls.)	Use mineral base oil. Climb to cruise altitude at full power and operate at 75% cruise power setting until oil consumption stabilizes.

SECTION 6
O-360 and ASSOCIATED MODELS
2. TROUBLE-SHOOTING—TURBOCHARGER

TROUBLE	PROBABLE CAUSE	REMEDY
Excessive Noise or Vibration	Improper bearing lubrication	Supply required oil pressure. Clean or replace oil line; clean oil strainer. If trouble persists, overhaul turbocharger.
	Leak in engine intake or exhaust manifold	Tighten loose connections or replace manifold gaskets as necessary.
	Dirty impeller blades	Disassemble and clean.
Engine will not Deliver Rated Power	Clogged manifold system	Clear all ducting.
	Foreign material lodged in compressor impeller or turbine	Disassemble and clean.
	Excessive dirt build-up in compressor	Thoroughly clean compressor assembly. Service air cleaner and check for leakage.
	Leak in engine intake or exhaust	Tighten loose connections or replace manifold gaskets as necessary.
	Rotating assembly bearing seizure	Overhaul turbocharger.
	Restriction in return lines from actuator to waste gate controller	Remove and clean lines.

O-360 and ASSOCIATED MODELS

SECTION 6

TROUBLE	PROBABLE CAUSE	REMEDY
Engine will not Deliver Rated Power (Cont.)	Exhaust bypass controller is in need of adjustment	Have exhaust bypass controller adjusted.
	Oil pressure too low	Tighten fittings. Replace lines or hoses. Increase oil pressure to desired pressure.
	Inlet orifice to actuator clogged	Remove inlet line at actuator and clean orifice.
	Exhaust bypass controller malfunction	Replace unit.
	Exhaust bypass butterfly not closing	Low pressure. Clogged orifice in inlet to actuator. Butterfly shaft binding. Check bearings.
	Turbocharger impeller binding frozen or fouling housing.	Check bearings. Replace turbocharger.
	Piston seal in actuator leaking. (Usually accompanied by oil leakage at drain line)	Remove and replace actuator or disassemble and replace packing.
Critical Altitude Lower than Specified	Controller not getting enough oil pressure to close the waste gate	Check pump outlet pressure, oil filters, external lines for leaks or obstructions.
	Chips under metering valve in controller holding it open	Replace controller.

SECTION 6
O-360 and ASSOCIATED MODELS

TROUBLE	PROBABLE CAUSE	REMEDY
Critical Altitude Lower Than Specified (Cont.)	Metering jet in actuator plugged	Remove actuator and clean jet.
	Actuator piston seal failed and leaking exces- sively	If there is oil leakage at actuator drain, clean cylinder and replace piston seal.
	Exhaust bypass valve sticking	Clean and free action.
Engine Surges or Smokes	Air in oil lines or actuator	Bleed system.
	Controller meter- ing valve stem seal leaking oil into manifold	Replace controller.
	Clogged breather	Check breather for re- strictions to air flow.

NOTE

Smoke would be normal if engine has idled for a prolonged period.

High Deck Pres- sure (Compressor Discharge Pres- sure)	Controller meter- ing valve not opening, aneroid bellows leaking	Replace controller as- sembly or replace aneroid bellows.
	Exhaust bypass sticking closed	Shut off valve in return line not working.
		Butterfly shaft binding. Check bearings.
		Replace bypass valve or correct linkage binding.

O-360 and ASSOCIATED MODELS
SECTION 6

TROUBLE	PROBABLE CAUSE	REMEDY
High Deck Pressure (Compressor Discharge Pressure) (Cont.)	Controller return line restricted	Clean or replace line.
	Oil pressure too high	Check pressure 75 to 85 psi (80 psi desired) at exhaust bypass actuator inlet.
		If pressure on outlet side of actuator is too high, have exhaust bypass controller adjusted.
	Exhaust bypass actuator piston locked in full closed position. (Usually accompanied by oil leakage at actuator drain line).NOTE: Exhaust bypass normally closed in idle and low power conditions.Should open when actuator inlet line is disconnected.	Remove and disassemble actuator, check condition of piston and packing or replace actuator assembly.
	Exhaust bypass controller malfunction	Replace controller.

INSTALLATION AND STORAGE

Page

Preparation of Engine for Installation	7-1
General	
Inspection of Engine Mounting	7-2
Oil and Fuel Line Connections	7-2
Preparation of Carburetors and Fuel Injectors for Installation	7-2
Corrosion Prevention in Engines	
Installed in Inactive Aircraft	7-3

SECTION 7**INSTALLATION AND STORAGE**

1. PREPARATION OF ENGINE FOR INSTALLATION. Before installing an engine that has been prepared for storage, remove all dehydrator plugs, bags of dessicant and preservative oil from the engine. Preservative oil can be removed by removing the bottom spark plugs and turning the crankshaft three or four revolutions by hand. The preservative oil will then drain through the spark plug holes. Draining will be facilitated if the engine is tilted from side to side during the above operation. Preservative oil which has accumulated in the sump can be drained by removing the oil sump plug. Engines that have been stored in a cold place should be removed to an environment of at least 70°F. (21°C.) for a period of 24 hours before preservative oil is drained from the cylinders. If this is not possible, heat the cylinders with heat lamps before attempting to drain the engine.

After the oil sump has been drained, the plug should be replaced and safety-wired. Fill the sump or external tank with lubricating oil. The crankshaft should again be turned several revolutions to saturate the interior of the engine with the clean oil. When installing spark plugs, make sure that they are clean, if not, wash them in clean petroleum solvent. Of course, there will be a small amount of preservative oil remaining in the engine, but this can cause no harm. However, after twenty-five hours of operation, the lubricating oil should be drained while the engine is hot. This will remove any residual preservative oil that may have been present.

CAUTION

Do not rotate the crankshaft of an engine containing preservative oil before removing the spark plugs, because if the cylinders contain any appreciable amount of the mixture, the resulting action, known as hydraulic, will cause damage to the engine. Also, any contact of the preservative oil with painted surfaces should be avoided.

SECTION 7**O-360 and ASSOCIATED MODELS**

General - Should any of the dehydrator plugs, containing crystals of silica-gel or similar material, be broken during their term of storage or upon their removal from the engine, and if any of the contents should fall into the engine, that portion of the engine must be disassembled and thoroughly cleaned before using the engine. The oil strainers should be removed and cleaned in gasoline or some other hydrocarbon solvent. The fuel drain screen located in the fuel inlet of the carburetor or fuel injector should also be removed and cleaned in a hydrocarbon solvent. The operator should also note if any valves are sticking. If they are, this condition can be eliminated by coating the valve stem generously with a mixture of gasoline and lubrication oil.

Inspection of Engine Mounting - If the aircraft is one from which an engine has been removed, make sure that the engine mount is not bent or damaged by distortion or misalignment as this can produce abnormal stresses with the engine.

Attaching Engine to Mounts - See airframe manufacturer's recommendations for method of mounting the engine.

Oil and Fuel Line Connections - The oil and fuel line connections are called out on the accompanying installation drawings.

Propeller Installation - Consult the airframe manufacturer for information relative to propeller installation.

2. PREPARATION OF CARBURETORS AND FUEL INJECTORS FOR INSTALLATION.

Carburetors and fuel injectors that have been prepared for storage should undergo the following procedures before being placed in service.

Carburetor (MA-4-5, MA-4-5AA) - Remove the fuel drain plug and drain preservative oil. Remove the fuel inlet strainer assembly and clean in a hydrocarbon solvent. Reinstall the fuel drain plug and fuel inlet strainer assembly.

Carburetor (PSH-5BD) - Remove the fuel inlet strainer and all plugs leading to the fuel chambers. Drain preservative oil from the carburetor. Clean the fuel inlet strainer in a hydrocarbon solvent. Reinstall fuel inlet strainer and replace all plugs.

Remove plug opposite the manual mixture control needle and drain any accumulated moisture from the air chamber. Replace plug.

With the throttle lever in the wide open position and the manual mixture control in the full rich position, inject clean fuel through the fuel inlet connection at 5 psi until clean fuel flows from the discharge nozzle.

CAUTION

Do not allow fuel or oil to enter into the air chamber.

Move the throttle lever to the closed position and the mixture control lever to the idle cut-off position. Because this carburetor has a closed fuel system, it will remain full of fuel as long as the mixture control lever is in the idle cut-off position.

NOTE

It is necessary that this carburetor soak for an eight hour period before starting the engine. The soaking period may be performed prior to or after installation on the engine.

Fuel Injector (Bendix). Remove and clean the fuel inlet strainer assembly and reinstall. Inject clean fuel into the fuel inlet connection with the fuel outlets uncapped until clean fuel flows from the outlets. Do not exceed 15 psi inlet pressure.

**CORROSION PREVENTION IN ENGINES INSTALLED
IN INACTIVE AIRCRAFT**

Corrosion can occur, especially in new or overhauled engines, on cylinder walls of engines that will be inoperative for periods as brief as two days. Therefore, the following preservation procedure is recommended for inactive engines and will be effective in minimizing the corrosion condition for a period up to thirty days.

NOTE

Ground running the engine for brief periods of time is not a substitute for the following procedure; in fact, the practice of ground running will tend to aggravate rather than minimize this corrosion condition.

- a. As soon as possible after the engine is stopped, move the aircraft into the hangar, or other shelter where the preservation process is to be performed.

SECTION 7**O-360 and ASSOCIATED MODELS**

b. Remove sufficient cowling to gain access to the spark plugs and remove both spark plugs from each cylinder.

c. Spray the interior of each cylinder with approximately (2) ounces of corrosion preventive oil while cranking the engine about five (5) revolutions with the starter. The spray gun nozzle may be placed in either of the spark plug holes.

NOTE

Spraying should be accomplished using an airless spray gun (Spraying Systems Co., "Gunjet" Model 24A-8395 or equivalent). In the event an airless spray gun is not available, personnel should install a moisture trap in the air line of a conventional spray gun and be certain oil is hot at the nozzle before spraying cylinders.

d. With the crankshaft stationary, again spray each cylinder through the spark plug holes with approximately two ounces of corrosion preventive oil. Assemble spark plugs and do not turn crankshaft after cylinders have been sprayed.

The corrosion preventive oil to be used in the foregoing procedure should conform to specification MIL-L-6529, Type 1, heated to 200°F./220°F. (93°C./104°C.) spray nozzle temperature. It is not necessary to flush preservative oil from the cylinder prior to flying the aircraft. The small quantity of oil coating the cylinders will be expelled from the engine during the first few minutes of operation.

NOTE

Oils of the type mentioned are to be used in Avco Lycoming aircraft engines for corrosion prevention only, and not for lubrication. See the latest edition of Avco Lycoming Service Instruction No. 1014 and Service Bulletin No. 318 for recommended lubricating oil.

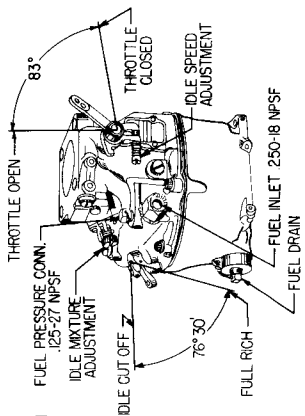

MA-4-5

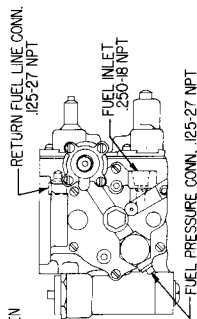

PSH-580

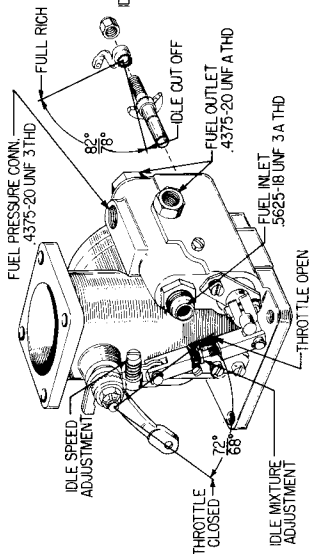

RSA-5401

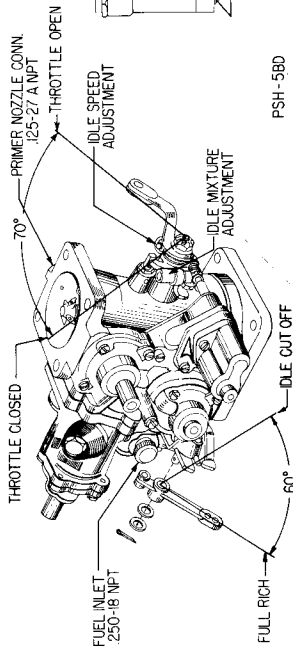

Figure 7-1. Fuel Metering Systems

SECTION 7

O-360 and ASSOCIATED MODELS

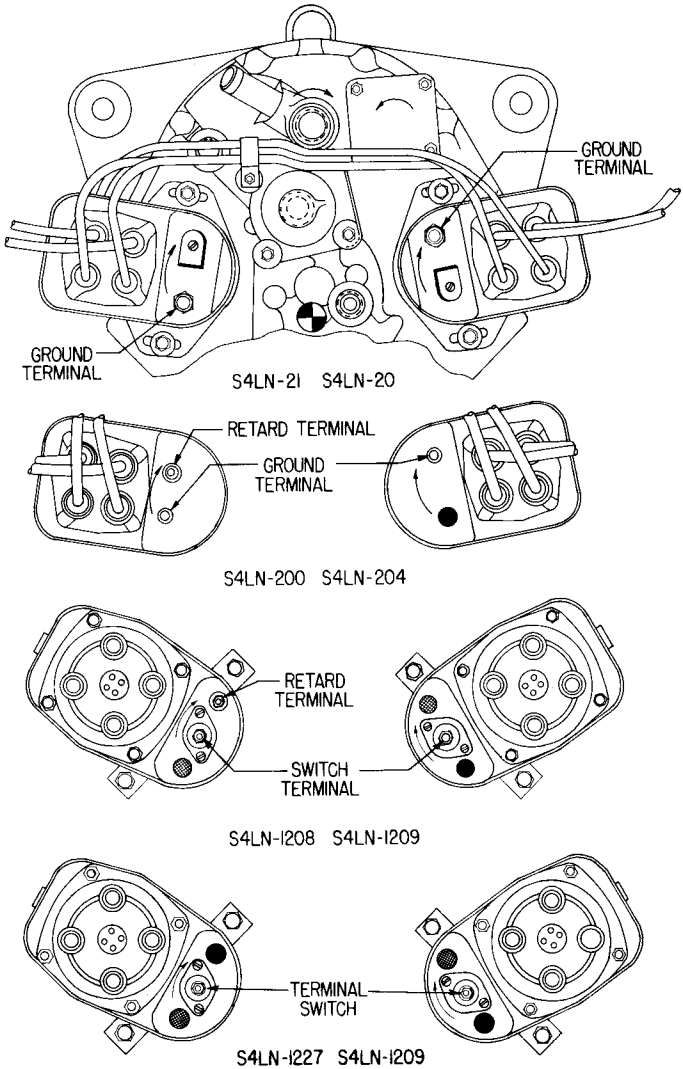

Figure 7-2. Magneto Connections

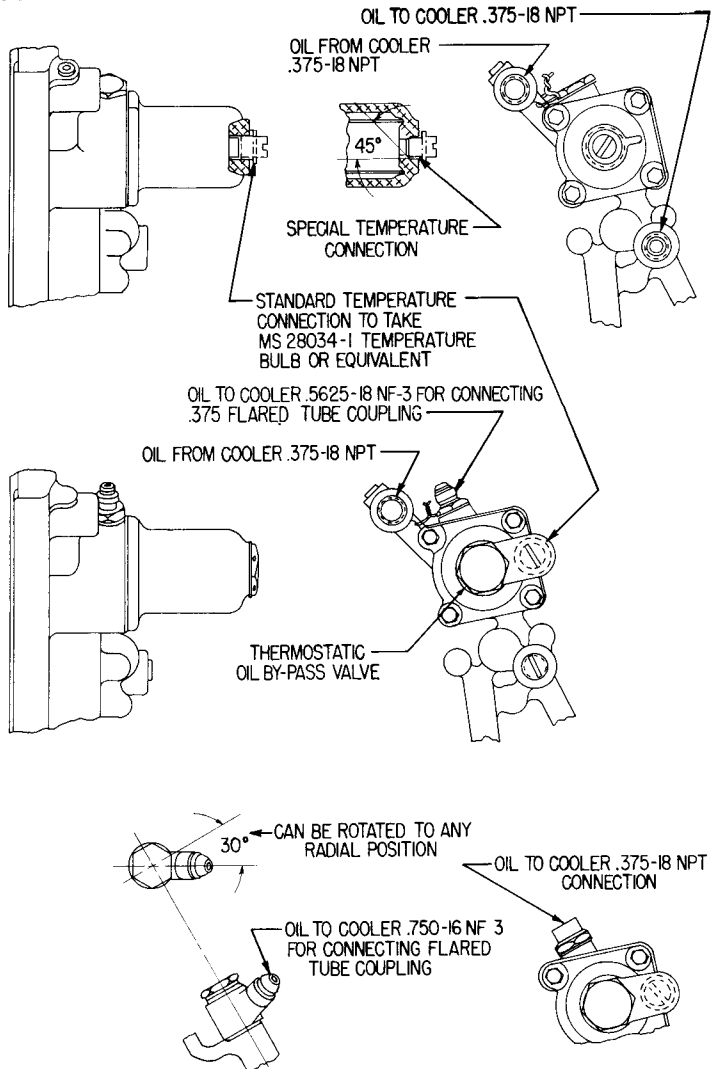
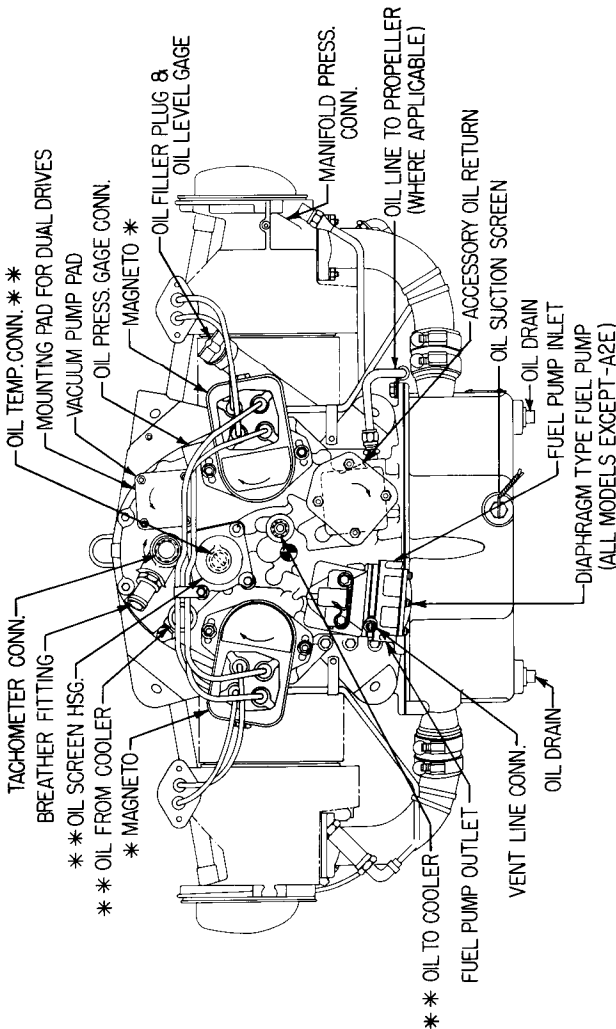
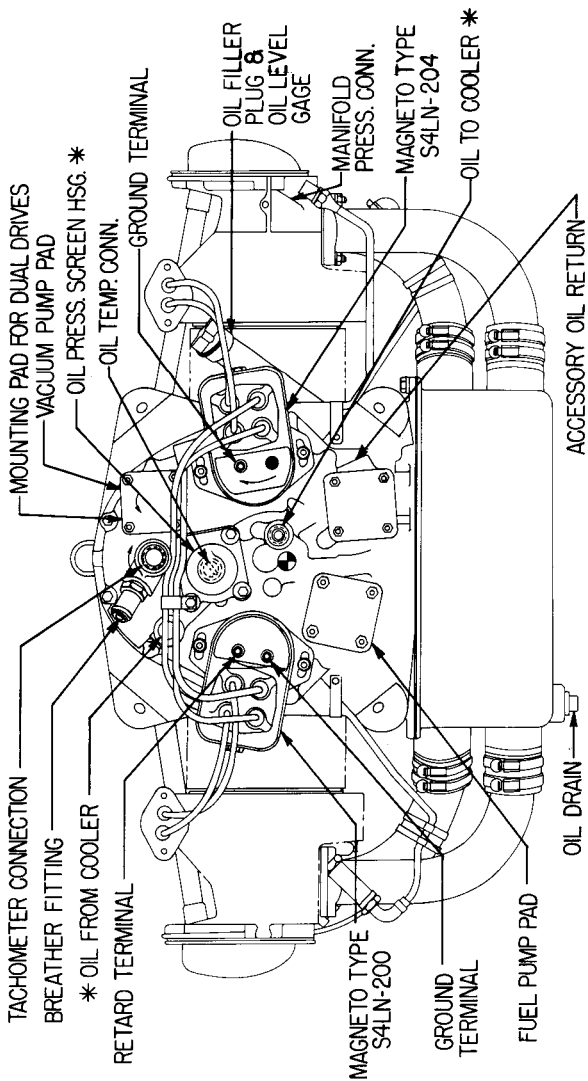

Figure 7-3. Optional Oil Cooler Connections

SECTION 7
O-360 and ASSOCIATED MODELS

* SEE FIG. 7-2 FOR MAGNETO CONNECTIONS
 * SEE FIG. 7-3 FOR OPTIONAL CONNECTIONS

Figure 7-4. Installation Drawing - O-360-A, -B Series
 Excepting -A1C, -A1G



* SEE FIG. 7-3 FOR OPTIONAL CONNECTIONS

Figure 7-5. Installation Drawing - O-360-A1C, IO-360-B1C

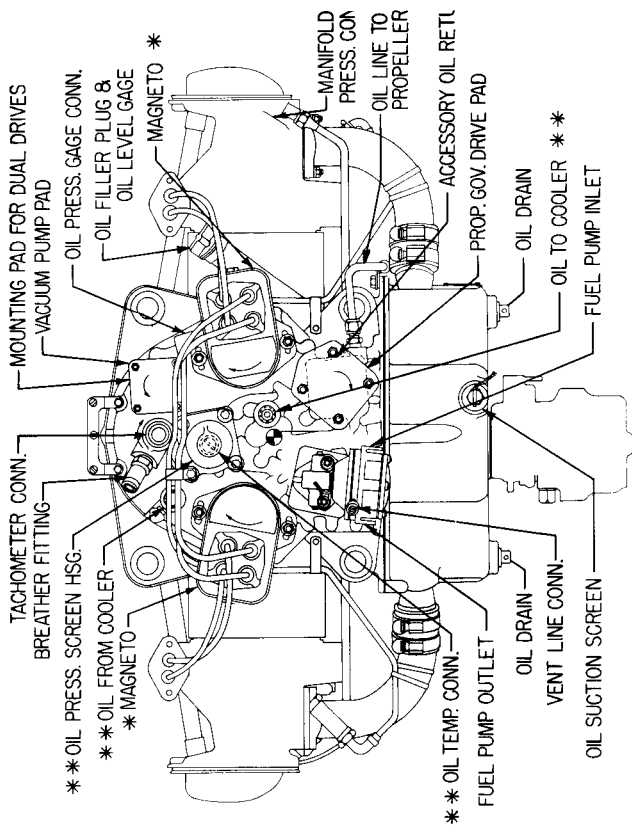
SECTION 7
O-360 and ASSOCIATED MODELS

**** SEE FIG. 7-2 FOR MAGNETO CONNECTIONS**

**** SEE FIG. 7-3 FOR OPTIONAL CONNECTIONS**

**Figure 7-6. Installation Drawing - O-360-C, -D Series
Excepting -C2B, -C2D**

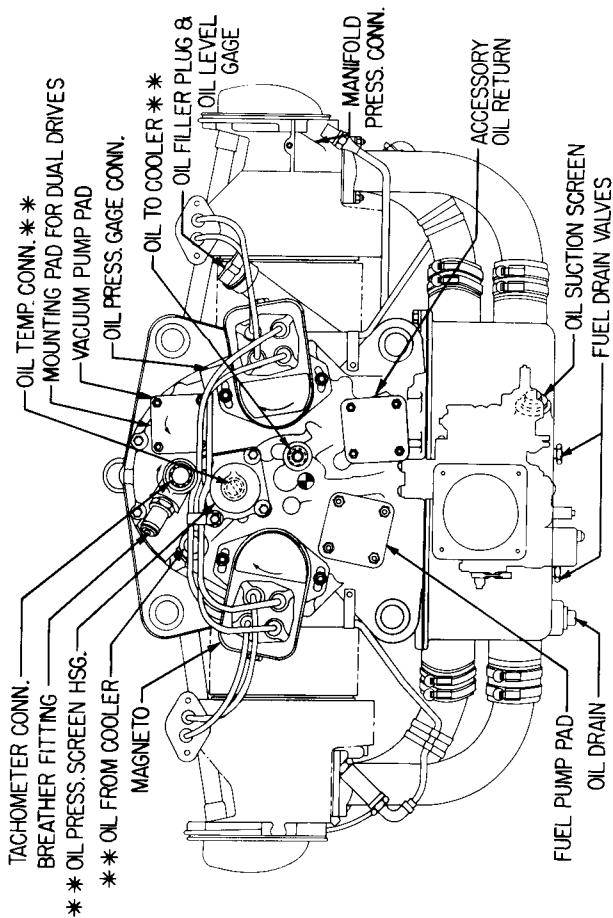

* SEE FIG. 7-2 FOR MAGNETO CONNECTIONS
 ** SEE FIG. 7-3 FOR OPTIONAL CONNECTIONS

Figure 7-7. Installation Drawing - O-360-C2B, -C2D, HO-360-B1A, -B1B

SECTION 7

O-360 and ASSOCIATED MODELS

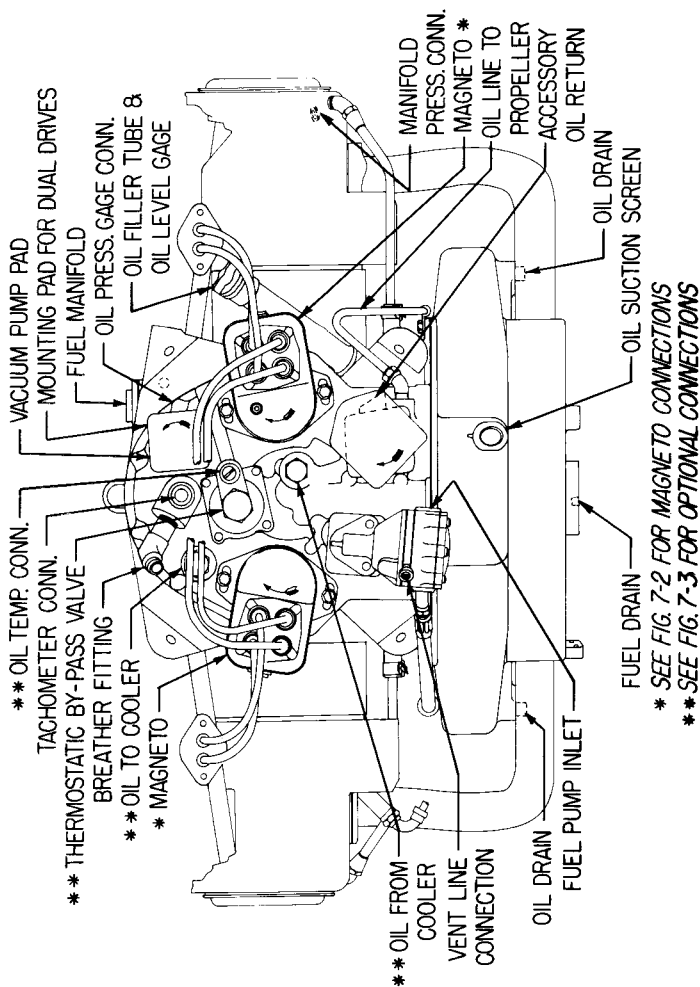
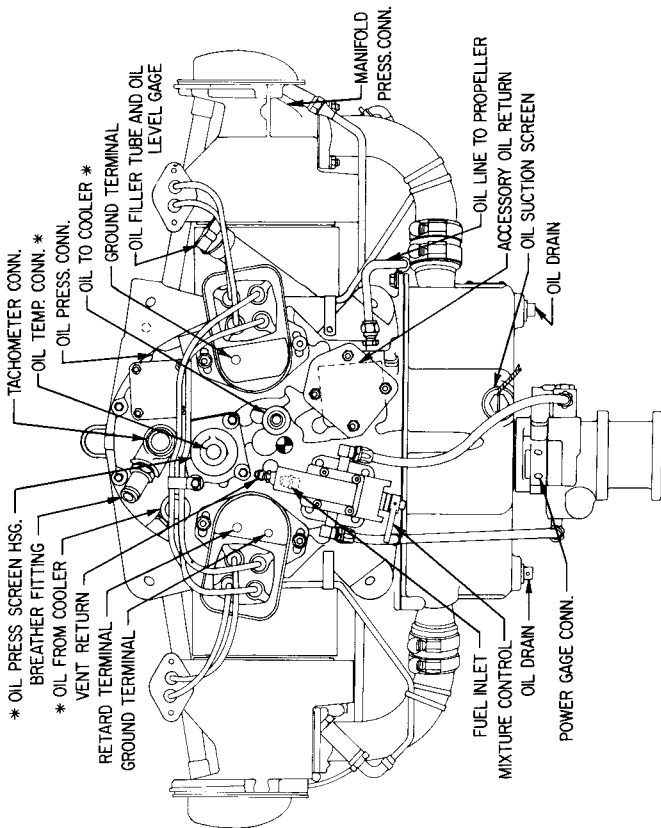

Figure 7-8. Installation Drawing - IO-360-A Series



** SEE FIG 7-3 FOR OPTIONAL CONNECTIONS*

Figure 7-9. Installation Drawing - IO-360-B1A

SECTION 7

O-360 and ASSOCIATED MODELS

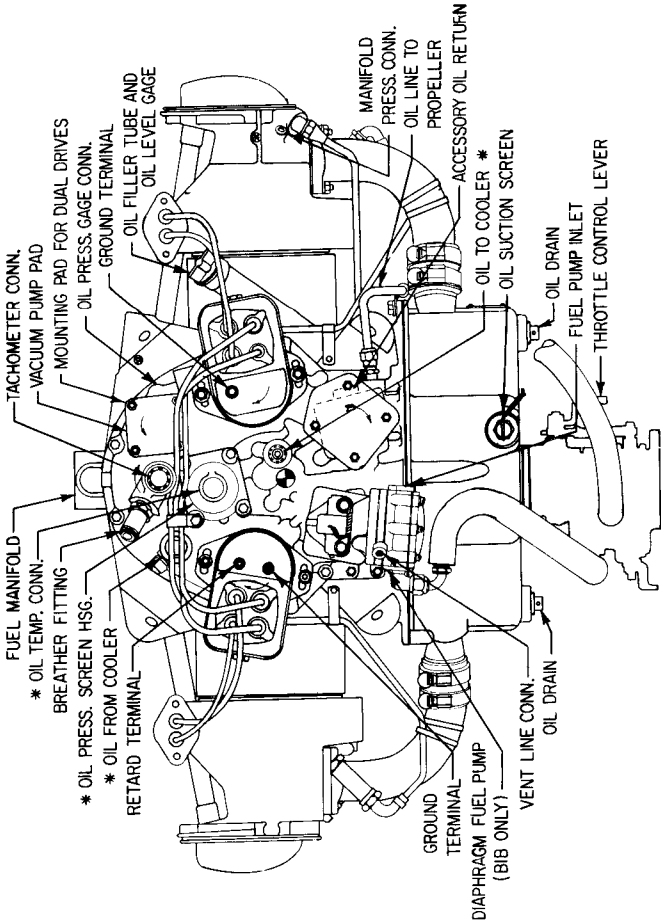

* SEE FIG. 7-3 FOR OPTIONAL CONNECTIONS

Figure 7-10. Installation Drawing - IO-360-B1B, -B1D

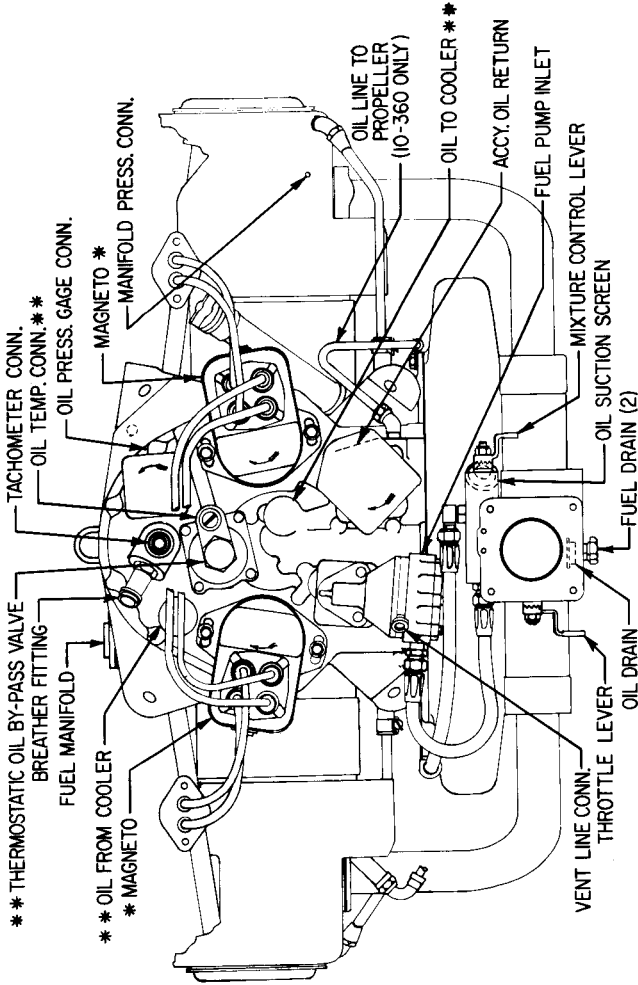

**** SEE FIG. 7-2 FOR MAGNETO CONNECTIONS**
**** SEE FIG. 7-3 FOR OPTIONAL CONNECTIONS**

Figure 7-11. Installation Drawing - IO-360-C1A, -C1B, -D1A, H10-360-C1A, -C1B

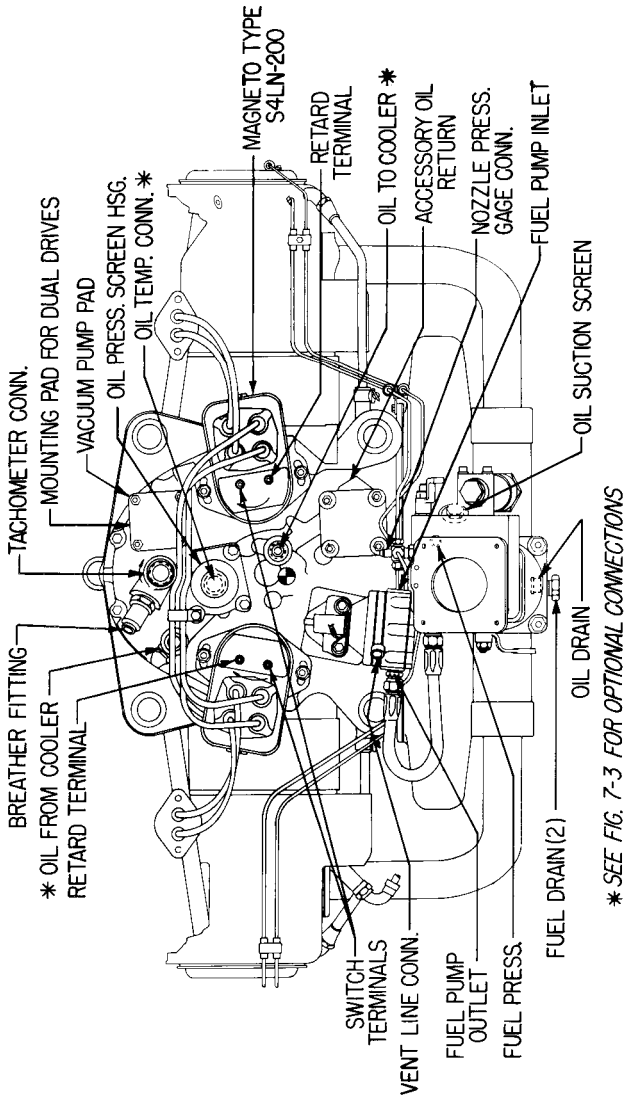
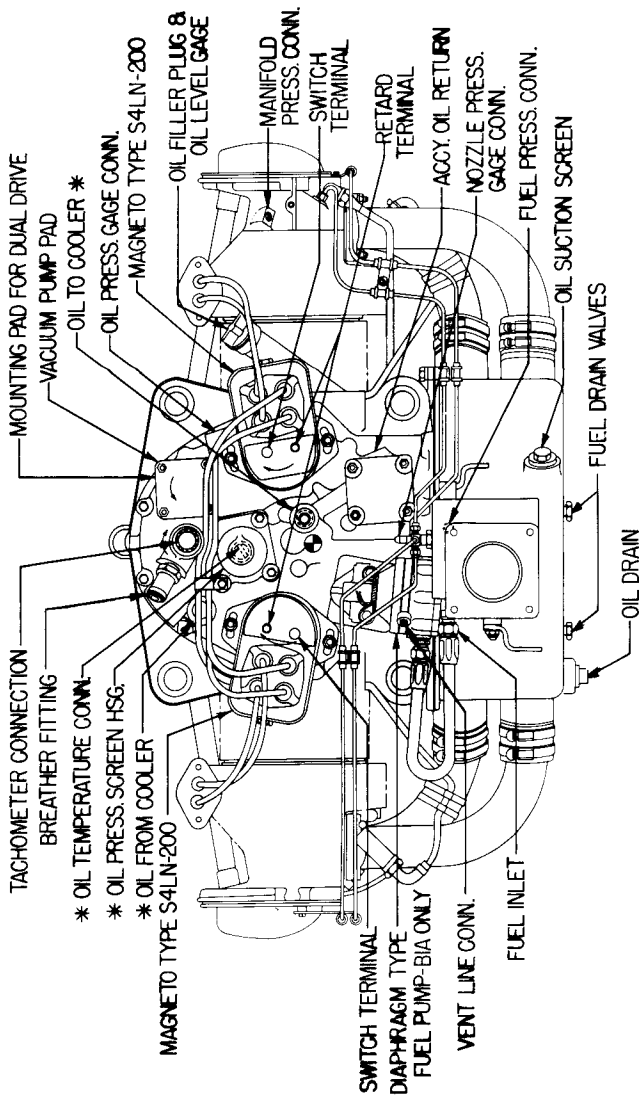

Figure 7-12. Installation Drawing - HIO-360-A1A



*** SEE FIG. 7-3 FOR OPTIONAL CONNECTIONS**

Figure 7-13. Installation Drawing - H10-360-B1A, -B1B

TABLES

	Page
Table of Limits8-1
Ground Run After Top Overhaul8-2
Flight Test After Top Overhaul8-3
Full Throttle HP at Altitude8-4
Table of Speed Equivalents8-4
Centigrade - Fahrenheit Conversion Table8-5
Inch Fraction Conversions8-6

SECTION 8**TABLES**

FOR TIGHTENING TORQUE RECOMMENDATIONS AND INFORMATION CONCERNING TOLERANCES AND DIMENSIONS THAT MUST BE MAINTAINED IN AVCO LYCOMING AIRCRAFT ENGINES, CONSULT LATEST EDITION OF SPECIAL SERVICE PUBLICATION NO. SSP2070.

CONSULT LATEST EDITION OF SERVICE INSTRUCTION NO. 1029 AND NO. 1150 FOR INFORMATION PERTINENT TO CORRECTLY INSTALLING CYLINDER ASSEMBLY.

SECTION 8
O-360 and ASSOCIATED MODELS

FIXED WING ONLY																		
GROUND RUN AFTER TOP OVERHAUL OR CYLINDER CHANGE WITH NEW RINGS (DO NOT USE AFTER MAJOR OVERHAUL)				Type Aircraft _____		Registration No. _____		Aircraft No. _____		Owner _____								
				Engine Model _____ S/N _____		Date _____		Run-Up By _____										
GROUND RUN																		
Time	RPM	MAP	Temperature				Pressure				Fuel Flow							
			L.oil	R.oil	L.cyl	R.cyl	L.oil	R.oil	L.fuel	R.fuel		L.carb	R.carb	Amb.	Air	Left	Right	
5 min	1000																	
10 min	1200																	
10 min	1300																	
5 min	1500																	
5 min	1600																	
5 min	1700																	
5 min	1800																	
Mag. Check			Adjustment Required						After Completion of Ground Run									
Power Check									1. Visually inspect engine(s)									
Idle Check									2. Check oil level(s)									

FLIGHT TEST AFTER TOP OVERHAUL OR CYLINDER CHANGE WITH NEW RINGS

1. Test fly aircraft one hour.
2. Use standard power for climb, and 75% power for cruise.
3. Make climb shallow and at good airspeed for cooling.
4. Record engine instrument readings during climb and cruise.

Tested by _____

FLIGHT TEST RECORD

Time	RPM	Temperature		Pressure		Temperature		Fuel Flow							
		L.oil	R.oil	L.cy	R.cy	L.oil	R.oil	L.fuel	R.fuel	L.carb	R.carb	Amb.	Air	Left	Right
(Climb)															
Cruise															

Adjustments Required After Flight

After Test Flight

1. Make careful visual inspection of engine(s).
2. Check oil level(s).
3. If oil consumption is excessive (see operator's manual for limits) then remove spark plugs and check cylinder barrels for scoring.

SECTION 8
O-360 and ASSOCIATED MODELS
FULL THROTTLE HP AT ALTITUDE
 (Normally Aspirated Engines)

Altitude Ft.	% S. L. H. P.	Altitude Ft.	% S. L. H. P.	Altitude Ft.	% S. L. H. P.
0	100	10,000	70.8	19,500	49.1
500	98.5	11,000	68.3	20,000	48.0
1,000	96.8	12,000	65.8	20,500	47.6
2,000	93.6	13,000	63.4	21,000	46.0
2,500	92.0	14,000	61.0	21,500	45.2
3,000	90.5	15,000	58.7	22,000	44.0
4,000	87.5	16,000	56.5	22,500	43.3
5,000	84.6	17,000	54.3	23,000	42.2
6,000	81.7	17,500	53.1	23,500	41.4
7,000	78.9	18,000	52.1	24,000	40.3
8,000	76.2	18,500	51.4	24,500	39.5
9,000	73.5	19,000	50.0	15,000	38.5

TABLE OF SPEED EQUIVALENTS

Sec./Mi.	M. P. H.	Sec./Mi.	M. P. H.	Sec./Mi.	M. P. H.
72.0	50	24.0	150	14.4	250
60.0	60	22.5	160	13.8	260
51.4	70	21.2	170	13.3	270
45.0	80	20.0	180	12.8	280
40.0	90	18.9	190	12.4	290
36.0	100	18.0	200	12.0	300
32.7	110	17.1	210	11.6	310
30.0	120	16.4	220	11.2	320
27.7	130	15.6	230	10.9	330
25.7	140	15.0	240	10.6	340

CENTIGRADE—FAHRENHEIT CONVERSION TABLE

Example: To convert 20°C. to Fahrenheit, find 20 in the center column headed (F—C); then read 68.0°F. in the column (F) to the right. To convert 20°F. to Centigrade; find 20 in the center column and read -6.67°C. in the (C) column to the left.

<u>C</u>	<u>F—C</u>	<u>F</u>	<u>C</u>	<u>F—C</u>	<u>F</u>
-56.7	-70	-94.0	104.44	220	428.0
-51.1	-60	-76.0	110.00	230	446.0
-45.6	-50	-58.0	115.56	240	464.0
-40.0	-40	-40.0	121.11	250	482.0
-34.0	-30	-22.0	126.67	260	500.0
-28.9	-20	-4.0	132.22	270	518.0
-23.3	-10	14.0	137.78	280	536.0
-17.8	0	32.0	143.33	290	554.0
-12.22	10	50.0	148.89	300	572.0
-6.67	20	68.0	154.44	310	590.0
-1.11	30	86.0	160.00	320	608.0
4.44	40	104.0	165.56	330	626.0
10.00	50	122.0	171.11	340	644.0
15.56	60	140.0	176.67	350	662.0
21.11	70	158.0	182.22	360	680.0
26.67	80	176.0	187.78	370	698.0
32.22	90	194.0	193.33	380	716.0
37.78	100	212.0	198.89	390	734.0
43.33	110	230.0	204.44	400	752.0
48.89	120	248.0	210.00	410	770.0
54.44	130	266.0	215.56	420	788.0
60.00	140	284.0	221.11	430	806.0
65.56	150	302.0	226.67	440	824.0
71.00	160	320.0	232.22	450	842.0
76.67	170	338.0	257.78	460	860.0
82.22	180	356.0	243.33	470	878.0
87.78	190	374.0	248.89	480	896.0
93.33	200	392.0	254.44	490	914.0
98.89	210	410.0	260.00	500	932.0

INCH FRACTIONS CONVERSIONS
Decimals, Area of Circles and Millimeters

Inch Fraction	Decimal Equiv.	Area Sq. In.	MM. Equiv.	Inch Fraction	Decimal Equiv.	Area Sq. In.	MM. Equiv.
1/64	.0156	.0002	.397	1/2	.5	.1964	12.700
1/32	.0312	.0008	.794	17/32	.5312	.2217	13.494
3/64	.0469	.0017	1.191	35/64	.5469	.2349	13.891
1/16	.0625	.0031	1.587	9/16	.5625	.2485	14.288
3/32	.0937	.0069	2.381	19/32	.5937	.2769	15.081
7/64	.1094	.0094	2.778	39/64	.6094	.2916	15.478
1/8	.125	.0123	3.175	5/8	.625	.3068	15.875
5/32	.1562	.0192	3.969	21/32	.6562	.3382	16.669
11/64	.1719	.0232	4.366	43/64	.6719	.3545	17.065
3/16	.1875	.0276	4.762	11/16	.6875	.3712	17.462
7/32	.2187	.0376	5.556	23/32	.7187	.4057	18.256
15/64	.2344	.0431	5.593	47/64	.7344	.4235	18.653
1/4	.25	.0491	6.350	3/4	.75	.4418	19.050
9/32	.2812	.0621	7.144	25/32	.7812	.4794	19.844
19/64	.2969	.0692	7.540	51/64	.7969	.4987	20.241
5/16	.3125	.0767	7.937	13/16	.8125	.5185	20.637
11/32	.3437	.0928	8.731	27/32	.8437	.5591	21.431
23/64	.3594	.1014	9.128	55/64	.8594	.5800	21.828
3/8	.375	.1105	9.525	7/8	.875	.6013	22.225
13/32	.4062	.1296	10.319	29/32	.9062	.6450	23.019
27/64	.4219	.1398	10.716	59/64	.9219	.6675	23.416
7/16	.4375	.1503	11.112	15/16	.9375	.6903	23.812
15/32	.4687	.1725	11.906	31/32	.9687	.7371	24.606
31/64	.4844	.1842	12.303	63/64	.9844	.7610	25.003



OPERATOR'S MANUAL

REVISION

REVISION No.	PUBLICATION	PUBLICATION No.	PUBLICATION DATE
60297-12-5	0-360 and Associated Models	60297-12	January, 1976

The page(s) furnished herewith are intended either to replace, add to, or delete pages in the basic manual.

Previous revisions to this publication	This revision consists of:-
January 1977 1-6 2-3, 2-5, 2-8, 2-10 3-1, 3-9, 3-12 4-6 March 1977 1-5 2-8, 2-9 3-4 July 1977 1-5 2-8, 2-9 September 1977 1-6 2-8, 2-9	December 1977 1-5 2-8, 2-9 All the revision pages are incorporated in the book.